

# **THE GOLDEN BOOK**

of

Rotary International

## **DISTRICT 5130**

and its earlier numbers

13

23

2

104

155

513

5130

### **A BRIEF HISTORY OF ROTARY SERVICE IN DISTRICT 5130**

Originally published in recognition of 50 years (1915-1965)  
of Rotary in District 513 as edited  
by P.M. Bliss, District Governor, 1962-63  
Later updated by District Archivists  
Don Lind and Bob Lundy  
PDG Charlie Strobe, editor 1970-1995  
PDG Jack Valerga, 2006



## CONTENTS

	Page
Highpoints of Rotary Development	v.
Dedication	viii.
Highpoints of District Development	x.
Foreward	xi.
1915-1918 – District 13	1
1918-1922 – District 23	4
1922-1937 – District 2	6
1937-1949 – District 104	12
1949-1957 – District 155	32
1957- – District 513 (Territory altered in 1970)	46
Charter Dates of Clubs	Appendix I
District Chronology	Appendix II



PAUL HARRIS



## HIGHPOINTS OF ROTARY DEVELOPMENT

Rotary was founded by Paul P. Harris, a Chicago lawyer. He conceived the idea of a club of business and professional men banded together socially, with each having exclusive representation for his particular craft so that members might be mutually helpful in a business way.

On February 23, 1905, Paul Harris held a meeting in his office with his friends and clients, Silvester Schiel, a coal dealer; Gustavus Loehr, a mining engineer; Harry Ruggles, a printer; and Hiram Shorey, a merchant tailor. These men continued to meet at each others offices, starting what came to be known as "The Chicago Rotary Club." This rotation of meeting places was designed to acquaint the members with each other's vocation. At each meeting the chairman "rotated," and from this practice they chose the name "Rotary."

The National Association of Rotary Clubs was formed in 1910, became the International Association in 1912, and shortened its title to "Rotary International" in 1922. During its first ten years, direction and guidance of member Rotary clubs was provided by the national officers.

On August 15-17, 1910, the first Convention of Rotary was held in Chicago. Sixty Rotarians attended from sixteen clubs and adopted a written constitution. Paul Harris was elected as first president of the "National Association of Rotary Clubs."

An active group of San Francisco businessmen started the surge of Rotary around the world. After the Chicago birth of this oldest of service clubs in 1905, no expansion occurred for three years. In June, 1908, Manuel Munoz, a member of the Chicago Rotary Club was in San Francisco. By chance he met Homer Wood, a young San Francisco attorney, and interested him in such an organization. Homer enlisted the support of a number of business leaders, and formed San Francisco as Rotary club number 2 on November 12, 1908, with Homer Wood as its charter president.

With typical western initiative, in rapid succession San Francisco Rotarians stimulated the organization of Oakland (Tri-city) number 3, Los Angeles number 4, Seattle number 5, Tacoma number 8, and Portland number 15 -- all by June 1910.

Between 1910 and 1920 Rotary clubs were established in Canada, Ireland, England, and Cuba, making it truly international in scope.

Rotary's insignias was developed from a wagon wheel design presented in 1906 by Montague M. Bear, an engraver. In 1912 the geared wheel replaced it as the official emblem; and in 1924 the present wheel of six spokes, twenty-four cogs, and a "keyway" was defined.

Although neither expression has ever been officially adopted, the two Rotary slogans originated early in the organization's existence. At the first Convention in 1910, a Chicago Rotarian, Arthur F. Shelton, made the statement, "He Profits Most Who Serves Best" and this wording was incorporated into the Rotary platform adopted at the second Convention held in Portland, Oregon. At the Portland Convention Frank Collins of the Minneapolis Rotary Club used the words, "Service, not Self" in a speech, and this proved to be a popular expression, later being changed to "Service Above Self."

An official Rotary flag, having a background of white with a Rotary wheel of blue and gold in the center, was adopted in November 1914.

At the Houston Convention in 1914, a "code of trade ethics" was adopted. At the San Francisco Convention in the following year, a change of emphasis was made from business reciprocity toward business as service to the public and a revised code was adopted.

The idea of a standard club constitution as at present adhered to was approved at the Los Angeles Convention in 1922. This constitution can be amended only by Rotary International in international convention.

At the 1951 Atlantic City Convention the four objects of Rotary were changed to one: "To encourage and foster the ideal of service as a basis of worthy enterprise," with the earlier four objects as underlying extensions of the basic one.

Herbert J. Taylor, 1954-55 International president, attained Rotary fame by expressing his ideals of Rotary in the "Four-way Test." In the form of a desk ornament or wall plaque, found not only in the offices of Rotarians but many public places in Rotary communities, the influence of the

four-way test has spread worldwide:

1. Is it the truth?
2. Is it fair to all?
3. Will it build goodwill and better friendship?
4. Will it be beneficial to all?

A Rotary Endowment Fund was started by International President Arch Klumph of Cleveland, Ohio, in 1917. At the Minneapolis Convention of 1928 the name of the Fund was changed to the Rotary Foundation. In 1938, at the second San Francisco Convention a goal of \$2,000,000 was set for the Rotary Foundation, to be obtained from voluntary contributions of Rotarians and others. Contributions lagged for a number of years, until the death of Paul Harris on January 27, 1947. A great surge of contributions from all over the world subscribed the initial goal many times over and thus Foundation Fellowships are a monument to the founder of Rotary.

One of the few letters in Paul Harris' handwriting preserved in District 513, the one reproduced below, was his acknowledgment that Rotary expanded from California. It was received by Governor "Pat" O'Hara just before the Santa Cruz "Friendly" Conference of April 1940.

Paul P. Harris  
PRESIDENT EMERITUS  
Rotary International

"Comely Bank"  
10856 Longwood Drive  
CHICAGO, ILLINOIS, U.S.A.

To the friendly Conference of Rotary  
International, Santa Cruz, Cal. gentlemen:

I have no hesitations about commending you in advance on the success of your Conference. The California spirit of enthusiasm, cooperation and optimism and the inspirational setting in Santa Cruz New Civic Auditorium justifies my confidence.

California's receptivity to the Rotary movement has always been a great encouragement to those of us who have been interested in the promotion of the Rotary ideal throughout the world.

Cholera prospects in several Eastern cities had been spread to the Rotary fever before the epidemic broke out in San Francisco in 1908. A traveler had carried the germ from Chicago to the Pacific Coast City. The virulence of the contagion was further manifested by outbreaks in Oakland, Seattle and Los Angeles almost overnight. This gave us something to talk about in our attempts to infect citizens of New York, Boston and other cities of the East and Central West. Success in Chicago was no longer all that we had to point to. The most significant thing was not the spread but the timeliness of it. It was prophetic of what was to happen in California and elsewhere throughout the world.

To my friends of Santa Cruz Friendly Conference  
Congratulations, full measure of gratitude and best wishes  
from your admirer and friend  
APR 10 1940 Sincerely  
Paul Harris





**HENRY J. BRUNNIER**

President, Rotary Club of San Francisco, 1913-14

Governor, District 13, 1915-16

2nd Vice-President, International Association of Rotary Clubs, 1917-18

President, Rotary International, 1952-53

This Golden Anniversary History of District 513, Rotary International, is respectfully and affectionately dedicated to Henry J. ("Bru") Brunnier, founder of the "District concept" in Rotary and first Governor of our District.

## HENRY J. BRUNNIER

Most Rotary clubs have a "Mr. Rotary" who is the sage and knowing counselor to whom members turn for guidance and questions on Rotary. Throughout half a century of Rotary membership and service, Bru Brunnier has established himself as "Mr. Rotary" of the Redwood Empire district of California.

"Go west, young man!" was an early challenge accepted by the young engineering graduate from Iowa. Establishing his headquarters in San Francisco, young Brunnier accepted and met many challenges as he rose to become a structural engineer of world-wide prominence. Professional projects took him to all parts of the earth, and many great structures stand as landmarks to his genius. As chief consulting engineer for the San Francisco Bay Bridge, Bru planted in the heart of his Rotary district one of his most magnificent achievements.

In 1908, as a charter member of the Rotary Club of San Francisco, Bru began a period of Rotary service that brought recognition paralleling in stature that attained in his profession. On the few occasions when he refused Rotary assignments, he did so because of a greater claim on his professional services in the national interest.

Early in his Rotary career, the esteem and confidence held for Bru by his fellow Rotarians were demonstrated. His selection as President of the San Francisco club, and later his nomination as District Governor, was not by vote, but by acclamation! Recognition of his leadership qualities was reflected in numerous responsible committee chairmanships and assignments in Rotary International, and by his election to the vice-presidency of the International Association in 1917. The election of Henry J. Brunnier to the presidency of Rotary International in 1952 brought to the office a leader whose professional responsibilities had caused the honor to be many times deferred.

Perhaps no man in Rotary had a more interesting series of humorous, exciting, and inspirational incidents happen to him than Bru experienced in his half century of Rotary service. And he would be quick to admit that many of them involved an equally dedicated and interested "Rotarian," Mrs. Ann Brunnier. Her fame, too, will also long endure in Rotary because of a famous incident in 1914.

In 1914 "Bru" Brunnier was president of the San Francisco club, which wanted to host the 1915 Convention. A special Rotary train was arranged to transport members of the thirteen clubs on the Pacific Coast to the Convention in Houston. Mrs. Brunnier and Mrs. Merrill were the only ladies on the train.

Since Rotarians had reached the stage where they called each other by their first or nicknames, it was natural that one should ask Mrs. Brunnier her first name. When she replied, "Ann," the group quickly nicknamed her "Our Rotary Ann." Enroute a ditty was developed, called "Rotary Ann."

When the group left the train at Houston, they trooped around the station singing the ditty. Guy Gundaker, a Philadelphian who later became president of Rotary International, was at the station with his wife. When he remarked that his wife's name was also Ann, the group pulled her along with Mrs. Brunnier, proclaiming that,

"From now on, all of the ladies of Rotary shall be known as Rotary Anns."

The history of the area included in District 513 of Rotary is interwoven with the achievements, leadership, and complete dedication of a man to the service and ideals of Rotary. This man was Bru Brunnier.



## HIGHPOINTS OF DISTRICT DEVELOPMENT

H. J. Brunner was the originator of the district idea, which was stimulated by the regional fellowship at a six-city meeting he attended at Tacoma, Washington, in 1914. Returning from Seattle on the three-day train trip, "Bru" awakened in the middle of the night with an idea. He had the porter bring the railroad time schedule, which had a map of the United States on it.

Knowing most of the approximately 100 clubs, he put dots on the map to show their location. Then he combined them on the basis of rail transportation and came up with 13 groups. The map and idea formed the basis for the decision to form Rotary districts that was adopted at the 1915 San Francisco Convention.

Directed to form the districts, in his courteous way "Bru" gave the last number to the West, and so our first district number was 13.

In 1918 "Bru" was again called on to redistrict, and we again received the largest number, 23. Called upon a third time in 1923, he worked with a redistricting committee, instead of alone. Because the district idea was first conceived in the Northwest, that area became number 1, and our present district became part of number 2.

Redistricting, though an increasingly stormy process as clubs developed a strong district feeling, continued. In 1938 the present geographical area was included in redesignated District 104. It remained the same when renumbered 155 in 1950. District 513 comprised the same area when the present number was assigned in 1958.

During the second quarter-century of its existence, District 513 (and earlier 104 and 155) has maintained an enviable stature in the Rotary world. Clubs in this geographical area have grown in number from 2 to 54. The district has consistently been in the high ten of the attendance contest involving all clubs in the United States, Canada, and Bermuda. And although smaller in number of clubs than many, District 513 has continued to be largest in number of Rotarians, with over 4000 in 1965. Only District 644 (which includes Chicago) has provided more International presidents than 513; and seven Rotarians from the north coast of California have served additionally as vice-presidents or directors of Rotary International.

Today, Rotary visitors from all parts of the world are greeted with friendly fellowship in clubs of the Redwood Empire district. Drawn by the scenic beauty of the forested Pacific slope, engaged in businesses aligned with the progressive commercial enterprises of all kinds found in 513, seeking knowledge available through our centers of research or higher education, or pausing briefly in journeys past the Golden Gate -- our visitors truly find a Rotary home away from home in clubs of Rotary District 513.

## FOREWORD

Organizations of all kinds flourish and grow in proportion to the dedication and strength of their leaders. The growth and strength of Rotary International reflects the service given its districts over the years by its district governors.

The history of district 513 mirrors, and is closely aligned with, the Rotarians who have served as its governors. As this record is concerned chiefly with the geographical area that has comprised this district for twenty-five years, it reports only briefly the early years when the governor was from another area.

1964-65 Governor Stanley McCaffrey conceived and implemented the preparation of this book as a golden anniversary tribute to present and former District 513 Rotarians. All living past governors contributed extensive information from their files, and secretaries of the clubs of governors now deceased assisted greatly in obtaining fugitive facts. Much appreciation is due these fine Rotarians whose efforts are reflected in the pages that follow.

P. M. Bliss



## DISTRICT 13

1915 - 1918

(New Mexico, Arizona, Nevada, California, Hawaii, the Philippines)

Two clubs in the present area were chartered before the district organization was initiated in 1915. San Francisco was founded as club number 2 in November of 1908, and number 116 was given to the Rotary Club of San Jose on its chartering in March of 1914.

Before the district organization was established, M. Louis Wooley of San Francisco was a director of the International Association of Rotary Clubs in 1912-13. During the 1917-18 year H. J. Brunnier of San Francisco was the second vice-president of Rotary International.

No new clubs were formed in the present geographical area during the remaining years of District 13.

Following Bru's term as first governor in 1915-16, Homer W. Sumption of San Diego headed the district in 1916-17, and Dr. Dewey R. Powell of Stockton in 1917-18.

## HENRY J. BRUNNIER

1915 - 1916

Known throughout the Rotary world as "Bru", Henry J. Brunnier was a gentleman in every sense of the word. Quietly forceful, he and Mrs. Brunnier (the original Rotary Ann) formed an outstanding team to direct and encourage Rotary understanding and growth throughout Arizona, California, Hawaii, Nevada, and New Mexico.

World-famous as a consulting structural engineer, through his travels Bru established a world-wide circle of friends both in and out of Rotary. His drive and dedication was evident to all, and established a standard of leadership that succeeding governors strived to equal.



In 1915 the clubs in District 13 were nine; San Francisco, Oakland, Los Angeles, San Diego, Stockton, Sacramento, Phoenix, Arizona, San Jose, and Honolulu. During the year four new clubs were added. Although the organization of new clubs later became a formalized procedure, in its earlier years extension of Rotary was chiefly a matter of personal acquaintance and the impetus of the District Governor.

In November 1915 an Oakland Rotarian named Wright was transferred to Fresno as the representative of his oil company. Bru had a meeting with him before he went to Fresno and explained how to go about organizing a Rotary club. Wright was given the names of a couple of acquaintances of Bru's in Fresno, but outside of these Wright knew nobody in Fresno. But Wright was a good Baptist and the next thing Bru knew, an acquaintance of his wrote from Fresno saying, "You'd better advise your organizer down here that he's getting all Baptists!" So Bru wrote and told him, "Lay off --- no more Baptists!" Soon after a group of San Francisco and Oakland Rotarians went to Fresno and completed the organization of a new club in December 1915.

At that time the International Association of Rotary Clubs believed that no club could be organized in a city of less than 90,000 people. The breakdown of this idea begun in Fresno was continued in the organization of the Berkeley club. At the time there were three distinct identities in Berkeley: South Berkeley, Central Berkeley, and the Telegraph Avenue section. While an Oakland member, V. O. Lawrence, was busy locating potential members in each of the three areas of Berkeley, Bru obtained permission from the International organization to establish a club in Berkeley. Both were successful and Berkeley became the eleventh club in the district in February of 1916.

In June of 1916 Bru went to Albuquerque and through an acquaintance was introduced to Dr. Shortle, who proved much interested in organizing a Rotary club. They met at lunch with 4 or 5 others and these in turn selected 4 or 5 more each. The group met again in the afternoon with these, and that night at a dinner Albuquerque was organized!

The International convention of 1916 was in Cincinnati. Prior to leaving on the train to the convention, Bru had had some preliminary correspondence with individuals in Reno. He left a day early, and organized the Reno club at a noon meeting just before the train left. And so club number 248 was formed!

Earlier, on the way to the organization meeting in Fresno it was decided that it would be wise for the clubs of the district to get together in a conference. At the organization meeting in Fresno, Bru suggested that the new Fresno club host the first district conference. Probably no new club ever had a more challenging assignment or one that was carried out more successfully, as Fresno hosted the first conference in February of 1916. With not more than 1200 Rotarians in California, and most of the conference participants from the state, a registration of over 300 Rotarians appeared at the Fresno conference. The impact of business of the conference was apparent in its timing - an early bulletin to San Francisco Rotarians noted that the special train would leave on Monday, February 21, at 4 in the afternoon and would return Wednesday, the 23rd, at 7:30 a.m. -- only one business day missed!



The present method of financing district activities was initiated at the Fresno conference, as it agreed to have each club contribute 50¢ per member toward the expenses of the office of the District Governor. A more important outcome of the conference, however, resulted from the heated discussions about small town Rotary clubs. Although Bru was in favor of extending Rotary into smaller communities, many Rotarians at the conference were strongly in opposition and swung sentiment against the idea. Joseph Lee, a San Francisco Rotarian, finally turned the tide of the discussion by a humorous yet serious presentation criticizing big city Rotarians while pointing out how the principles of Rotary could thrive in small communities. The final favorable action of the conference thus actually became the stimulus that caused the International Association to approve the formation of Rotary clubs in smaller cities.

With some chagrin, Bru recalled how his request of each club in the district to present a stunt at the conference caused him some embarrassment. At one of the sessions, the Los Angeles group filled the front rows of the balcony. As Bru was conducting the meeting, he noticed that an altercation appeared to be going on in the balcony, and that men were pushing and shoving each other close to the railing. While attempting to restore order from his position on the platform at the front of the hall, Bru was horrified to see a body hurdle over the railing to the floor below. This was the Los Angeles "stunt", because what had actually fallen was a dummy!

Although in its first year of district organization, Rotary had yet to outgrow the concept of membership for business reasons, there were many evidences that Service was emerging as the real foundation of Rotary. Development of state-wide highways and the provision for farm credits were given impetus through the influence of the several Rotary clubs. The approach of World War I brought with it many opportunities for community and national service that were accepted by clubs of the district. Perhaps the year could best be summarized by the title of one of the speeches given at the first conference. "Cooperative Optimism."

## DISTRICT 23

1918 - 1922

(New Mexico, Arizona, Nevada, California, Hawaii)

The same geographical area, comprising the states of the far west and Hawaii, was included in the newly numbered District 23. Clinton E. Miller of Los Angeles served as the first governor of the newly numbered district during 1918-19. He was followed by Alex Sheriffs of San Jose, who became the second governor from the present area.

In 1920-21 Leslie S. Everts of San Diego was governor, followed by Charles B. Bills of Sacramento who served as the last governor of District 23. During Bills' year five clubs included in the present district area were chartered: Vallejo on November 1, 1921, Santa Rosa December 1, 1921, Santa Cruz March 1, 1922, and Palo Alto and San Rafael were both chartered on May 1, 1922.

## ALEX SHERIFFS

1919 - 1920

Holding the classification education, Alex Sheriffs was superintendent of schools in San Jose, and during the 1919-20 year was concurrently president of the San Jose club and governor of the 23rd district.

A man of vision, great industry, and demonstrated leadership, Alex was a practicing lawyer as well as an educator. A leader in many organizations for civic betterment, he said, "I tried hard to live up to the ideals of these various organizations, and enjoyed them all."



Twelve new clubs were chartered during the year, all in California, increasing the number from 15 to 27. Within the present geographical area, Napa became club number 3 on its chartering April 1, 1920.

Stressing the importance of attendance as a goal, Alex encouraged competitive attendance in the different clubs. As a result the district record of attendance rose from 65% to 82% during the year. The San Jose club was highest during two months of the year.

The district Conference, held in Oakland March 30 and April 1, 1920, had a registration of 2000. "The Patriotism of Peace" was the keynote of the Conference, recognizing that the nations of the world had been torn apart by the first world war. This theme was symbolic of the attitude of Rotary International, which realized the need to extend the ideals of Rotary as an instrument of peace, and had succeeded in planting Rotary clubs in nearly all of the great cities of the world.

During the year community problems were a challenge, and clubs became increasingly active to accomplish successfully projects for better roads, more schools, better bridges, child welfare, playgrounds, boys work, and to sponsor other causes for community betterment.

A district-wide competition was held to define Rotary in approximately 50 words. Perhaps the best summation of Alex Sheriffs' year is the quoted winning definition: "Rotary is something which we feel, but is hard to define. Rotary is more than a name; it is a spirit and a life; a Rotary club is more than an organization; it is associated vision and effort; it transmutes kindly desires into helpful deeds, and turns dreams into accomplished facts. It is a training school in unselfishness, where personal gain is subordinate to public good. The Rotarian has an eye for a neighbor's need; a hand trained to help; a foot trained to paths of mercy; and a heart for true men, good women, and little children."

## DISTRICT 2

1922 - 1937

(Nevada, California, Hawaii)

As a result of the third redistricting, District 2 came into existence in 1922 with John R. Williams of Long Beach as its first governor. During his year Petaluma became the ninth club in the present district, receiving its charter on March 30, 1923.

Three Rotarians from the present area served as governors during the years of District 2: Paul Rieger of San Francisco in 1923-27; Almon E. Roth of Palo Alto in 1927-28, and Herbert K. Walton of San Rafael during the 1934-35 year.

The years 1924-27 were led by governors from areas other than the northern California coastal region. In 1924-25 Harry S. Mason of Los Angeles was the governor, and seven clubs were added to the present district. Mountain View was chartered on the 13th of September 1924. Following in sequence, Burlingame was admitted to Rotary on January 2, 1925, San Anselmo April 27, 1925, Ukiah April 29, Lakeport May 6, Hollister May 11, and Sebastopol became the 20th club in the present geographical area on May 26, 1925.

In 1925-26 Thomas B. Bridges of Oakland was the governor and again the present geographical area saw an extension of club growth. Gilroy was chartered on October 19, 1925. Arcata followed on February 8, 1926, then St. Helena March 8, Sunnyvale March 31, Cloverdale June 2, and Mill Valley became club number 26 on June 7, 1926.

In the following year Fred A. McClung of Huntingdon Park was governor. He chartered Fortuna on January 5, 1927, and Watsonville on May 21, 1927, as the 27th and 28th clubs in the present area.

In 1928-29 Herbert E. Harris of Whittier was governor of Rotary District 2. During that year the second vice-president of Rotary International was Almon E. Roth of San Francisco. Harvey B. Lyon of Oakland was governor of Rotary District 2 in 1929-30.

Arthur S. Crites of Bakersfield followed in 1930-31, serving under International President Almon E. Roth of San Francisco. In that year Guerneville became club number 29 in the present area, chartered June 6, 1931.

The depression years were dormant as far as club growth in the present district was concerned. David J. Reese of Ventura was governor in 1931-32 and Al Roth of San Francisco was on the Board of Directors of Rotary International. Charles D. Hayward of Berkeley was governor in 1932-33 and Edward B. DeGroot from Los Angeles in 1933-34.

During the last two years of the existence of District 2, the governors were from areas other than the Redwood Empire. George W. MacLellan of Santa Barbara served in the 1935-36 year, during which the Santa Clara club was chartered on June 13, 1936. Marshall DeMott of Corning was the last governor of District 2. At the conclusion of his 1936-37 service, the district included 170 clubs with approximately 8500 Rotarians.



## PAUL REIGER

1923 - 1924

The third governor from the present geographical area, Paul Rieger was a San Francisco businessman who manufactured perfume. Strong-minded and personable, his devotion to Rotary has become legendary in the district.

The number of anecdotes about Paul are endless, most illustrating the uniqueness of his personality. During the rollcall common in clubs in his day, when he responded he would say, "I am the 'scenter' of the earth!"



During 1923-24 four new clubs were added to the geographical area of the district. Eureka was chartered on November 9, 1923, Los Gatos and San Mateo both on January 15, 1924, and Calistoga became the thirteenth club on March 10, 1924.

At the beginning of the year there were 66 clubs in the district with a total membership of 4260. Eleven new clubs were formed during the year for a total of 77 in the geographical area of California, the Hawaiian Islands, and Nevada.

International guidance was given to the districts in this year by President Guy Gundaker who labeled Rotary - "Parliament of business today - Preserver of world's peace of the morrow - Builder of cities - Servants to all mankind." During his year Paul Rieger gave consistent evidence of following through on the theme of the International president. He considered Rotary to be a businessman's organization and considered the president and secretary of each club to be the executives with himself as the general manager. His monthly bulletins thus could be considered inter-office memos to the executives as there were found in them specific directives to the club officers, and in many cases instructions on how to carry out certain procedures.

During the 1923-24 year the district was organized to take advantage of the ability of the six past district governors and utilize them as area representatives. Each was asked to supervise the or a dozen clubs near their home city and to assist in following through on the plans for the year. Additionally, Paul asked each president to write him a monthly letter telling him of the achievements and progress of the club, and the secretaries to do likewise from their vantage point. He insisted that the club officers were the "selling agents" of Rotary and that they should consider themselves business executives to get the cooperation of the club membership. Promptness at meetings, effective arrangement of the meeting place, quality luncheons ("men get tired of veal cutlets every week"), more singing at club meetings, and revival of the old-time "rollcall" in clubs were some of the pointers that he emphasized in his messages to clubs.

Two Conferences of presidents and secretaries were held during the year, one in the Fall at Riverside and one in the Spring at San Jose, both running for two or three days. Insisting that the member clubs pay the expenses of their officers to these Conferences, Paul devised the plan whereby all clubs would pay an equal amount for the necessary transportation and expenses so that the clubs farthest distant would pay no more than those close to the site of the Conference. In this way in two or three years the costs to all clubs would average out.

Attendance was emphasized during the year. In the USCB competition reports District 2 topped all 40 districts for most of the year, with an average attendance of over 90%. Among the top clubs in the district at that time were several from the Redwood Empire including Napa, Palo Alto, and Petaluma.

Accomplishments in the district during the year included an increase in the number of club bulletins, many interclub meetings including one in Orange County involving seven clubs, and a major International service project to assist in Japanese relief through contributions to the rehabilitation fund established after the major earthquake in Japan. International Vice-President Frank Lamb spoke at the Spring Conference in San Jose which was expanded to include what is commonly thought to be the district-wide Conference.



Paul Rieger was a dominant force in the district for many years. Before the advent of the nominating procedure to select a district governor, the former governors would get together and agree on who would be an effective nominee. On one occasion all of the past governors except Paul got together and picked a man. At the Conference they thought they would secure his nomination without difficulty. But Paul had found out about the plan, had gone to all the smaller clubs and talked to them, and at the Conference his nominee won in a walk!

He felt it would be disastrous to again divide the state Rotarily and for many years was successful in preventing redistricting.

## ALMON E. ROTH

1927 - 1928

A brilliant lawyer from the Palo Alto club was the second Rotarian from the north coast of California to serve as governor of District 2.

Almon E. Roth was a personable, dynamic, and excellent speaker, whose inspired leadership received deserved recognition in the Rotary world.

Immediately following the 1927-28 year, Al centered his law practice in San Francisco, and he became a member of club number 2. In the most rapid rise in Rotary history, he was elected to the R.I. Board of Directors at the end of his year as governor, serving as Second Vice-President in 1928-29. Just one year later Al Roth took office as the twentieth president of Rotary International, holding that office during the 1930-31 year.



As the Roaring Twenties drew to a close, Rotary continued strong in District 2. Although no new clubs were added to the 28 located in the Redwood Empire of California, the 143 clubs in the district grew to 147 during the year.

Northern California and California clubs in general were developing the high standards of attendance that was to make the west coast the envy of all clubs in the United States, Canada, and Bermuda attendance contest. District 2 was found in the high ten during most of the year.

Because of the size of the district and the number of clubs involved, Governor Al was literally "on the road" during the major portion of his year, as he visited clubs and attended district functions.

All service aspects of Rotary continued to expand in clubs of the district and many noteworthy projects were carried out, especially in the fields of community service. Al stimulated interclub activity, resulting in many interclub and multiple club meetings during the 1927-28 year.

In May of 1928 the annual Conference was held in Sacramento. With over 4000 in attendance, it was probably the largest Conference that any district governor ever had. The governor's ball was held in the Civic Auditorium and was climaxed in a thrilling tribute to Al Roth, the Palo Alto club, and its location as the home of Stanford University. In the middle of a dance the doors of the auditorium flew open and in marched the entire Stanford band in full regalia, playing Stanford's famous marching song, "Here Comes the Band."

President Arthur Sapp, of Huntington, Indiana, sent as his personal representative Director Raymond J. Knoepfel of New York City. The stature of Governor Al Roth was reflected in the quality of Rotary participants he attracted as feature speakers at his Conference. These included Raymond Havens, 1922-23 Past President of Rotary International from Kansas City; Edward J. Flynn of St. Paul, Past Director; and Bill Manier of Nashville, later to become International President during the 1936-37 year.

As the Conference drew to its close, the 147 clubs of the second district proposed the name of Almon E. Roth for the office of Director of Rotary International.

Earlier in the year over 300 Rotarians assembled in Yosemite Valley for the annual Assembly. With all but six clubs represented, the beauty and semi-isolation of the area contributed to the outstanding fellowship and friendliness that characterized the meeting.

Although he took great pride in the installation of his son, Bill, as fourth president of the Rotary



Club of Belmont, Al Roth felt that the picture below typified the friendliness he found in all of Rotary.

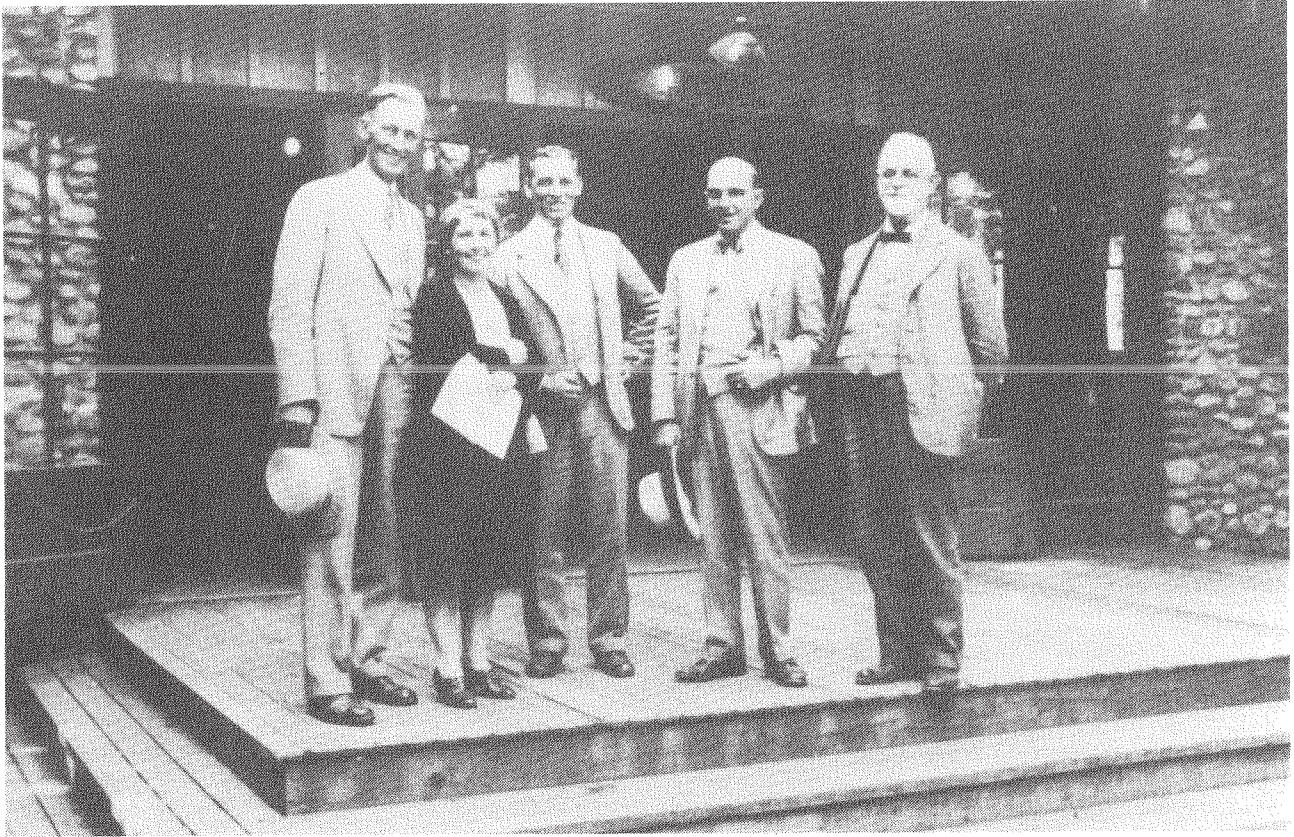

Taken during the Yosemite Assembly in 1927, it showed him centered among some of his friends and supporters. On the left is Bru Brunner, and Catherine McNulty, district secretary; and on the right Jack Williams of the Long Beach Rotary club, and Paul Rieger, 1923-24 governor from San Francisco.



## HERBERT K. WALTON

1934 - 1935

Later to serve as director of Rotary International, Herbert K. Walton of San Rafael was the second Rotarian from a club other than San Francisco to serve as district governor in the present geographical area. An excellent executive, the number of clubs in District 2 caused him to exchange most of his private business interests for Rotary service during the year. His move to New York City shortly after his year as governor deprived the district of the fine assistance that Herb could give in its continuing affairs.



Although two more years were to elapse before the northern California coastal area became the firm geographical area of the district, 1934-35 was the last year in which a governor was from a club in this area. Governor Herb started the year with 163 clubs with a total membership of 8106 members. At the close of the year two more clubs had been added and the total membership was 8481.

Although the district had grown in size, it was composed of active clubs, and as usual the district was excellent in attendance and was among the high ten of districts in the attendance contest. The Aims and Objects plan of Rotary operation having been placed in effect, all clubs were more or less active in the four avenues of service.

All clubs were represented at the district Assembly held at the Hotel del Monte in Monterey August 6-8, 1934. A highlight of the meeting was the presence of Rotary President Bob Hill of Missouri, representing the International organization. All but two of the fifteen past governors of the second district were in attendance and assisted in the presentation of various phases of the program.

Santa Monica hosted the district Conference May 13-15, 1935. This was the first time that a small club had hosted a conference of such size. The total registration of 2168 represented all but eight of the 165 clubs in the district. Past President Russell F. Greiner of Kansas City was the representative of the International President. Other Rotarians of international stature who were present and participated in the program included E. F. Harris, Honorary Commissioner of Rotary International, Shanghai; Director Robert F. Phillips, of Asheville, North Carolina, Past President Roth, Past Director Thomas J. Davis of Butte, Montana, and Past Vice-President Bru Brunnier. A highlight of the Conference was the presentation of a pageant by students of Compton Junior College entitled "The Summoning of the Nations."

Rotary interest continued high during the year, culminating in the filling of two special trains from the district to the Convention held in Mexico City in June 1935. Charlie Wheeler of San Francisco was elected to the Board of Directors at this Convention.

The stature of Herb Walton in Rotary International was recognized by his service on the council of legislation at the Convention, his appointment to the Aims and Objects Committee, and to the chairmanship of the Club Service Committee of Rotary International in the following year. He was also a member of the Extension Committee in 1935-36. In 1937-38 Herb served as a director of Rotary International.

## DISTRICT 104

1937 - 1949

(North Coast of California, Hawaiian Islands)

Following extensive study, by vote of all the clubs in the area included at the time in District 2 and ratification by Rotary International, the district was divided into five new ones, effective at the beginning of the 1937 year. These five California-Nevada districts included geographical areas much as they were to remain, and number 104 was assigned to the northern California coastal region.

The new district included 30 clubs extending from Hollister and Watsonville on the south up the California coast to include Arcata. During the twelve years of its existence as 104, the district was to grow to 43 clubs.



## CHARLES L. WHEELER

1937 - 1938

Charles L. Wheeler of San Francisco was a self-made man in every respect, who rose to high executive positions in intercoastal shipping. His ability was recognized in Rotary even before his year as district governor, because at the Mexico City Convention in 1935 he was elected to the Board of Directors of Rotary International, and during the following year served as its third vice-president. His experience at the International level did much to establish the new District 104 as a strong and cohesive Rotary unit. He later became President of Rotary International in 1943-44.



On January 11, 1938, another club of the district was formed as Garberville was chartered. The "baby" club was newest for only eight days, however, as the Rotary Club of Lower Lake was chartered on January 19, 1938. A total district membership of 1932 at the start of the year increased to 2081 at its close. The district continued to be high in its attendance standards with an approximate percentage of 90% for the year, and continual placement in the top ten attendance contest. Arcata, Cloverdale, Sunnyvale, Guerneville, and San Anselmo were consistently outstanding in attendance.

During the year Charlie Wheeler had two responsibilities that were unique. He was responsible for the formation of the new district of Hawaii. This was accomplished by bringing the number of clubs in the Islands to five so that it would qualify as a district and by assuming the leadership that gained approval of the new district from Rotary International on March 1, 1938.

In the year preceding the formation of Rotary districts, San Francisco had been host to the International Convention in 1915. Again in 1938 the San Francisco club and District 104 had the privilege and responsibility of hosting an International Convention. Thus most of the year was devoted to preparation for this outstanding event. The Convention was centered around President Maurice Duperrey's theme: "Development of the Four-Lane Highway." The presence of Herb Walton, 1934-35 governor, on the Board of Directors assisted in the local planning that was to serve the 10,000 registered at the Convention. Ed Whitney, the newly elected Executive Secretary of the San Francisco club, contributed greatly to the organizational planning and development as he entered on a period of service that was to extend more than thirty years.

As he had been in 1915, Bru Brunnier was again called on to head the host club convention committee for the 29th convention of Rotary International. Representing 194 foreign clubs from 48 nations and all areas of the United States, the Convention registration totaled 10,481. Two of the outstanding presentations at the Convention were made by Almon Roth, whose address "Men and Ships" was quoted often in following years in discussions of employer-employee relationships; and President Duperrey's "Around the World with Rotary" which told the story of his trip of nearly 10,000 miles during which he addressed over 50,000 Rotarians in his year.

Most of the major events of the Conference were housed in the Civic Auditorium, and this was also the setting of the House of Friendship. Visitors marveled at the precision with which the House of Friendship (including a central fountain weighing 12 tons centered in a 16-foot pool and over 3000 growing plants and 750 pieces of summer furniture) was whisked away to convert the area into a ballroom.

No separate district Conference was held during the year as it was combined with the International Convention. California-Nevada districts 105, 106, 107, and 108 joined with 104 to hold joint conference activities along with the convention. Governor Charlie's stature in Rotary was recognized by his responsible positions as Vice-Chairman of the Committee on Legislation and Chairman of the Drafting Committee on Legislation for Rotary International at the convention. His stature as a leader was also reflected in the stability of the district in the newly defined geographical area as it entered its second quarter century.

## FLOYD A. PARTON

1938 - 1939

After a lapse of twenty years, the Rotary Club of San Jose provided its second governor to the district in 1938-39. Floyd A. Parton was a former district manager of the Pacific Telephone Company and former president of a moving and storage company, who was president of a Savings and Loan Association during his tenure as district governor.

Perhaps best known for his lively sense of humor, Floyd was an outstanding business executive who brought to the district competent leadership based on his experience. A persuasive, forceful, and confident leader, he had the proud support of his home club and his two Rotarian sons.



Governor Floyd's year had an auspicious start, as he followed the excellent leadership of Charlie Wheeler, was a participant in, and was elected at the 1938 Rotary Convention in San Francisco. The concern of the Convention and much of the 1938-39 year was with the rumblings in Europe that preceded the onset of World War II. Rotary service directed toward international understanding and the maintenance of peace was reflected in many program topics and club service projects during the year.

Although no new clubs were brought into District 104, the healthy growth continued, as from a beginning membership of 1798 total membership grew to 1902 at the end of the year. Club attention to attendance was again reflected in the high approximate percentage of 91.56 for the year.

New officers participated in a district Assembly held in Vallejo early in the year. On July 29 and 30, 106 participants represented most of the clubs of the district as past governors assisted Floyd to indoctrinate incoming officers.

Former third vice-president of Rotary International, Tom Davis was the personal representative of President George Hager of Chicago at the district Conference. Held in San Jose April 24-26, 1939, the Conference registration of 1276 was a tribute to the organizational ability and leadership of Governor Floyd. The events of this colorful Conference were climaxed with a Spanish night, that attracted 2000 visitors to witness a dramatic portrayal of the Spanish heritage of California and the San Jose area.

San Jose was also host to the visit of the International President during the year. President Hager spoke to the Rotary Club of San Jose on December 27, 1938, emphasizing in his address that "the people of the world do not want war."

Floyd Parton was the butt of many a jest in his home club because of his personal lack of concern for pocket money. At one time or another he borrowed from most of the members to pay his luncheon charge. On one occasion the president asked how many Floyd owed money to, and the entire club stood up!

Throughout the year Governor Floyd emphasized the importance of strong club organization, adherence to the principles of Rotary, and the importance of inter-club and inter-community contacts and relationships. Unknowingly, his leadership set the stage for a stable Rotary existence that was to be tested by the throes of international conflict during the following six years.



## RUSSELL F. O'HARA

1939 - 1940

The Rotary Club of Vallejo provided its first district governor in the person of Russell F. O'Hara during the 1939-1940 year. Though handicapped by poor eyesight, Pat O'Hara showed an ability to recognize and stimulate club leadership in his travels throughout the district.

Genial, friendly, and considerate, Pat's astute approach to the solution of Rotary problems made him an effective participant in district functions in following years.



In its third year under the 104 designation, the district continued to grow. Despite the war in Europe and international unrest, Rotary interest and service in the district grew firmly under the leadership of Pat O'Hara.

From the beginning membership of 1883, the district grew to 1963 at the end of the year. Although the newer clubs of Guerneville and Garberville joined older Arcata, San Anselmo, and San Jose to establish strong attendance records, the district ended the year with a lower than average percentage of 82.86.

Eureka hosted the annual Assembly in August of 1939. One hundred and twenty-five new officers, representing most of the 32 clubs in the district, were indoctrinated into their duties for the year.

On April 25-26-27, 1940, the Rotarians of the district met in annual Conference at Santa Cruz. The meetings were the first event held in the newly constructed civic auditorium.

Entitled "The Friendly Conference," the 946 attending included many members of Rotary families, as well as Rotarians. Many events were designed to attract ladies and children, including tours of the nearby big tree groves, informal luncheons, events in the House of Friendship, and varied entertainment. Although in its initial planning the Conference committee had urged Governor Pat to feature in the new auditorium the musical extravaganza, George White's "Scandals," Pat's judgment prevailed, and Uda Waldrop brought his 16 fine singers from San Francisco. A long-time Rotarian and renowned San Francisco organist, Uda's group also included a number of San Francisco Rotarians. He brought his own piano from San Francisco for the event, and the tortuous road then traversing the Santa Cruz mountains did the piano little good. A skilled Santa Cruz piano tuner took half a day to put the instrument back in tune before the group was to sing!

Karl Miller, past director from Dodge City, Kansas, was International President Walter Head's personal representative to the Conference, which also featured outstanding presentations from Rotarians within the district.

Pat O'Hara's friendly personality and his effective extemporaneous speaking ability sparked not only the Conference but the entire year. In 1939-40 friendliness was emphasized not just at the Conference but during the entire year.

## HARRY A. MITCHELL

1940 - 1941

Harry A. Mitchell was the 1940-41 governor of district 104. As President of the Sacramento Northern Railway, Harry held the classification of Interurban Transportation in the Rotary Club of San Francisco. He typified the service-minded Rotarians who have taken time from an extremely busy business life to serve as district governor.

Harry's interest in individual clubs and individual Rotarians was evident throughout the year. Earnest and straightforward, by example he gave increased attention to the quality of leadership at the club level.



1940-41 was a stable year among clubs of the district. No new clubs were added, and the 32 had a beginning membership of 1940 that grew to 1980 at the end of the year.

Continuing its fine attendance record, the district remained in the top ten of the USCB attendance contest during the year, with average attendance exceeding 90%. Los Gatos, Mountain View, San Anselmo, Sunnyvale maintained enviably high attendance records; but Garberville led the district with 43 consecutive weeks of 100% attendance.

With the onset of World War II and Europe blazing into war, great opportunities were presented for international service through Rotary. At the International Convention in Havana in June of 1940, a resolution was adopted that established a Rotary Relief Fund. This Fund provided an opportunity for Rotarians in the United States to contribute voluntarily in assisting the alleviation of suffering and rehabilitation of Rotarians and their families in any part of the world where such need existed. The response from District 104 was exceptional. As the year neared its close the district's efforts were aligned with specific Rotary clubs in Britain to which relief contributions were made.

Leaders of the totalitarian countries in Europe were quick to realize that the objects of Rotary were not compatible with their interests, and the lights of Rotary were quietly extinguished in those areas. The Rotary Club of Fortuna had an unusual international service program in which all members stood for a minute in silence in honor of the members of the clubs in countries where Rotary was discontinued. At the conclusion of this salute the flags of the nations where Rotary had disappeared were removed from the flag stand. The flags were placed in a smaller, separate stand, there to remain until Rotary was re-established and the flags could be replaced in their original position.

Impetus to international understanding in Latin America was also extended during the year in honor of International President Armando Pereira of Brazil. Through the cooperation of Rotary International, many clubs in the district began to send at least one subscription of the "Revista Rotaria" to non-Rotarians in countries of Latin America. Individual clubs also assisted neighboring District 106 in the development of a shortwave radio broadcast directed to Latin America.

Hosted by the Rotary clubs of Sonoma County, the district Assembly was held July 26-27 in Santa Rosa. Presentations to the 87 attending included ample opportunity for questions by the incoming club officers, and were given by outstanding former International officers headed by past International officers Bru Brunnier and Al Roth. The district Conference was held in San Francisco April 18-19, 1941, with an attendance of 1498.

A number of joint and intercity meetings were held during the year. Two of particular stature were those that brought all Santa Clara County clubs to San Jose in an evening session attracting 225 persons, and the Sonoma County clubs' meeting in Petaluma on a March evening. First Vice-President Allison Ware visited the district and spoke at Sunnyvale, San Anselmo, Cloverdale, and Arcata on succeeding days in September.

During the year there was considerable evidence that the increased service of the International



Secretariat was being considered and used in the clubs and district. Particular emphasis was given to the development of an effective and continuous program of Rotary publicity, development of strong leadership within the clubs, and utilization of the resources of R.I. in establishing contacts for international service in the countries then feeling the brunt of World War II.

## ROY N. DREIMAN

1941 - 1942

The first governor from a club in the southern portion of the district was Roy N. Dreiman, of Santa Cruz. Because of the onset of World War II, Roy faced difficult problems in his business (as area manager of PG&E), as well as in the governorship, during the 1941-42 year.

Roy's warm personality, effective executive ability, and strong initiative combined to overcome many obstacles and keep Rotary strong in the district..



1941-42 was the only year in the history of the district where total membership decreased during the year. Rotarians leaving to meet the call of military or other national service reduced the total beginning membership of 1949 to 1904 at the end of the year.

Despite travel restrictions and multiple calls on Rotarians for service, the district attendance percentage was approximately 88.52 for the year.

Governor nominees were indoctrinated to their duties in Colorado Springs in May, and met their many new governor friends again at the International Convention in Denver. At that time Roy had no way of knowing that his new friends from the Philippines and other parts of the Far East would not be able to attend the 1942 Convention in Toronto.

Nor did he realize that in the coming year there would be gasoline and tire rationing; night driving with headlights dimmed so low that they were barely visible to approaching vehicles; and that California communities would live in constant fear of attack on the West Coast. "Business as usual" was decidedly not the order of the day that year.

An Assembly for new officers was held at San Mateo July 25-26, 1941, with an attendance of approximately 100.

The district Conference was scheduled to be held in Vallejo during the spring of 1942, but had to be cancelled because of wartime restrictions. However, the Oakland Rotary Club hosted a joint Conference April 26-29 where Rotarians from both districts found they had much in common. J. Carthell Robbins, International director from Stuttgart, Arkansas, was President Tom Davis' personal representative to the Conference. The 620 in attendance had stimulating discussions on vocational, club, community, and international service through which Rotarians from both districts found they had much in common.

In addition to the many who served their country in the armed services,, Rotarians and Rotary Anns participated in all of the wartime activities in their respective communities. These activities were to continue to draw Rotarians together in a spirit of service, and Rotary spirit and interest was high throughout the entire district during the year.

## FRANK BRENNAN

1942 - 1943

In 1942-43 Frank Brennan served as the first governor from a club in the far north of the district. A member of the Eureka club, Frank held the classification of security brokerage.

A big man, Frank's stature was matched by his friendliness and spirit in Rotary. His hearty laugh and sense of humor carried him through situations that would embarrass or stump others. He loved practical jokes, but never carried them to extremes. A great imitator, Frank could impersonate local or national people of distinction on the spur of the moment.

His leadership brought increased recognition to the strength of Rotary among clubs of California's northern coastal counties.



As Frank Brennan took the helm of District 104 in July of 1942, full attention of the nation and Rotary was being given to World War II. The California coastline was blacked out, war industries were surging, and young men in all communities were being drawn into the service.

The 32 clubs of the district began with a total membership of 1880, and grew slightly to 1931 at the end of the year. Although wartime restrictions curtailed much travel activity, district attendance continued strong with the clubs of Arcata, Garberville, San Anselmo, San Jose, and Los Gatos maintaining high averages during the year.

On August 7 and 8, 1942, 130 new club officers assembled in Santa Cruz to be indoctrinated into their duties for the year. Attention was centered at the Assembly on types of Rotary projects that could benefit their communities and at the same time serve the national effort.

Although usual travel activity curtailed many intercity and joint meetings, Governor Frank accepted invitations throughout the district and attended many special meetings. He earned the just distinction of knowing the names of more Rotarians than did most governors who preceded him. Combined with his jovial presence, this personal and individual recognition enabled Governor Frank to be highly effective in stimulating club leadership during the year.

International President Fernando Carbajal of Lima, Peru, sent as his personal representative to the district Conference immediate past president Tom Davis of Butte, Montana. Held in Eureka on April 16-17, 1943, despite travel difficulty the Conference attracted 250 participants. In later years, all who were present agreed that the fellowship of the first Eureka Conference was a never-to-be-forgotten experience.

Local industry and products, and the scenic beauty of the Redwood Empire were featured. With Chalmers Crichton as its secretary, the Conference committee arranged with the Pacific Lumber Company to furnish transportation, and members of the Conference traveled via logging train to one of its camp operations. Luncheon was served in shifts at the logging camp cookhouse. Spectators marveled at the size of a giant redwood tree that had been felled nearby.

Erwin S. Cobb, a noted humorist, writer and speaker of the time, was one of the featured participants of the program. He spoke and a redwood tree was dedicated in his honor at the Dyerville Memorial Grove near Eureka. The same day a picnic lunch of freshly caught Humboldt crab was served at Scotia Park.

In addition to Tom Davis, Rotary International was represented at the Conference by former president Almon Roth, Bru Brunnier, presidential-nominee Charles Wheeler, and former governor Pat O'Hara. A number of north coast Rotarians were featured in the Conference program, and one of them brought gasps of astonishment at his feats of magic. Glyndon "Sign" Smith, a Eureka Rotarian

and master of necromancy, entertaining at a luncheon, made a locally caught gigantic salmon disappear!

The 1942-43 year ended on a high note for the district, as at the St. Louis Convention in June of 1943, Charles Wheeler was elected President of Rotary International.



## MERVYN HITCHCOCK

1943 - 1944

Western manager for an insulated wire and cable company, Percy Robinson of San Mateo was elected governor of District 104 at the 1943 St. Louis Convention. Robbie died just as the 1943-1944 year began, and past governor Harry Mitchell served for a short time as acting governor.

Mervyn Hitchcock was elected by the Board of Directors of Rotary International to replace Robbie. A member of the San Mateo club, holding the classification of life insurance, Merv served the remainder of the year. A serious but warm person, Merv worked successfully during the year to overcome the handicap of lack of formal training for the governor's duties provided by the International Assembly.



During 1943-1944, the 32 clubs of District 104 were proud to be the home district of the President of Rotary International. With Charles Wheeler of San Francisco at the International helm, Rotary in his Redwood Empire District continued to thrive during the difficult war years.

Although no new clubs were added, district membership grew for the first time to exceed 2000, as a total membership of 2077 was recorded at the end of the year. Although rationing and travel restrictions made it difficult to travel to attend other clubs in make-up attendance, the district record of attendance continued high with 84.48% for the year.

In one of the infrequent changes that occur in Rotary, on March 13, 1944, the Rotary Club of Lower Lake changed its name to Clear Lake Highlands.

Governor Merv led the district to stimulate Rotary service in avenues peculiar to wartime. Emphasis was placed on the conservation of resources, assisting the promotion of sales of war bonds, and in furthering USO and similar activities in areas of military installations. While many younger Rotarians entered the armed services, those of greater maturity were found in many positions of civilian responsibility, assisting the war effort throughout the district and nation.

Early in July the district Assembly was held in Ukiah. At this July 9-10 meeting in 1943, the total attendance of 119 represented the new presidents and secretaries of most clubs of the district as they were formally indoctrinated into their duties for the year.

Fred L. Haas, past director of Rotary International, was designated by President Charlie as his personal representative to the seventh annual district Conference. Held in San Francisco, the meeting was limited to one day, April 17. With most participants coming from clubs close by San Francisco, the total attendance of 715 reflected the impact of World War II on Rotary travel.

As President Charles Wheeler turned over the gavel of his International presidency at the second successive International Convention in Chicago in June of 1944, it was with the knowledge that his home district had measured well to the standards of Rotary achievement during a difficult year.

## PRENTISS A. ROWE

1944 - 1945

Prentiss A. ("Bob") Rowe held the classification of jewelry-wholesale in the Rotary Club of San Francisco as he assumed the governorship for 1944-1945. Deeply interested in youth work, he brought to the district a background of interest in boys work and youth activities that had been demonstrated in his earlier Rotary activities and the presidency of the San Francisco Boys' Club.

A friendly and affable person, Bob was an astute businessman whose initiative was taxed to provide effective leadership to the district during difficult war years.



In 1944-45, America's participation in World War II limited considerably the activities of Rotary in the district. The 32 clubs in the district began the year with a total membership of 2077 and grew to 2187 by the following June. Even with restrictions on travel, the district maintained its high percentage of attendance with 87.55 for the year. San Jose, Garberville, San Anselmo, Burlingame, and Arcata in that order were the outstanding clubs in attendance.

Although Governor Bob did not have the advantage of indoctrination at an assembly of Rotary International, which was cancelled because of travel restrictions during the war, his was an exceptional year in three respects:

As fellow San Franciscan Charlie Wheeler was the immediate past president of Rotary International during the year, the attention of all districts was focused on 104. Second, Rotary International placed high emphasis on youth activities during the year. And third, San Francisco was the site of the organizing sessions of the United Nations during the year.

The R.I. youth work committee suggested as a mythical fifth Object for the year, the challenge to make "Every Rotarian a Friend of Youth." With his interests and background in youth work, Bob Rowe stimulated many clubs of the district to initiate new programs or to strengthen old in developing youth service in their communities. Many of these projects were continued and grew stronger in succeeding years across the district.

In May of 1945 the eyes of the world were focused on San Francisco as representatives of nations of the free world met in sessions that resulted in the organization of the United Nations. Because the community of interests was clear, many representatives from Rotary International were found in San Francisco during the conference. International President Dick Wells, Secretary Phil Lovejoy, Rotarian editor Leland Case, past presidents Allen Albert and Walter Head, and past director Luther Hodges were present during all or a portion of the conference. President Wells inspired a large meeting of Rotarians in San Jose as he spoke at an intercity meeting there on May 2.

In his visits to clubs Governor Bob emphasized the importance of larger attendance at the club Assembly held during this visit. He found that meeting with many members, rather than just with the officers and directors, was considered an innovation. The enlarged Assembly demonstrated its value through the opportunity provided the governor to discuss more intimately the objectives of the year with club members. As more members understood better the principles and objectives of Rotary, better individual Rotarians were developed.

Travel restrictions prevented holding a district Conference, and the only district meeting was a one-day Assembly held just preceding the start of the Rotary year. Hosted by the Rotary Club of San Rafael at the Meadow Club in Fairfax, the sessions featured presentations by past district governors, past R.I. directors and immediate past president Charles Wheeler. In lieu of the Conference, seven area assemblies were held in sections of the district during the year.

A question raised at the Assembly was, "Does the outgoing governor receive any grant from the district fund toward attending the International Convention?" Establishing the assurance of this support, past governor Merv Hitchcock reported that \$500-\$700 was provided, and that he had received \$500 toward his expenses for attending the 1944 Chicago Convention.

Rotary service throughout the district was affected by the impact of World War II on Rotarians, their families, and their communities. It did, however, stimulate an increased awareness and understanding of peoples, places, and other nations of the world.

At the conclusion of his year, Bob, in addition to reporting strong support and high participation of clubs in the district during a trying time, acknowledged that travel limitations had caused the district to require less financial assistance than had been anticipated. He thus refunded to each club \$2.10 per capita of the initial \$2.25 that had been contributed toward the district operations for the year!



## JOSEPH L. GABRIEL

1945 – 1946

Although all were respected, Joseph Gabriel ranked high among best-loved governors of the district. A member of the Rotary Club of Hollister, he held the classification, ice manufacturing.

Joe combined pride in Rotary and love for America in an inspiring speech that he was called upon to give on many important occasions. After hearing his emotion-charged talk, all would agree that pride in the American heritage was deeply rooted in the heart of this man who arrived as a penniless immigrant from Lebanon.

A sincere and devoted interest to each club and individual he met in Rotary during the year, put an unmistakable "Gabriel" stamp on all parts of District 104 during 1945-46.



The 2176 Rotarians in District 104 grew to 2394 during the 1945-46 year, and two additional clubs were chartered.

Redwood City was chartered on April 22, 1946, with 34 members. Sponsored by the Palo Alto and San Mateo clubs, the main speaker on that occasion was immediate past governor Bob Rowe.

On May 4, 1946, the Sonoma Valley Rotary Club received its charter. Sponsored by the Rotary Club of Napa, the 20 members were brought into Rotary at a festive occasion again featuring Bob Rowe as the main speaker.

During the year the attendance record of the district continued high, with a percentage of 88.21 for the year. San Jose continued to maintain an enviably high record for large clubs. The usual standing of the district among the top ten in the USCB attendance contest was upset in February when it dropped from 6th to 29th place. After a promotional effort to obtain 100% attendance of all clubs during one week in March, the resulting 98.27% was indicative of the support the district gave to Governor Joe.

Club and district activities during the year reflected concern for a return of sanity after the termination of World War II. Clothing drives to assist people affected by the war in Europe, joint interdistrict efforts to assist the International House at Berkeley, and numerous topics at district meetings relating to the challenging years ahead were examples of this concern. Although rationing of essentials drew to a close, the Rotary concern for certain essential consumer goods was shown by the fact that 24 pairs of nylon hose were presented to the "lucky ladies" at the district Conference.

Tom Warren, International president from England, spoke at the San Francisco club on January 29, 1946. All clubs in the district had been invited and all were represented.

Sonoma Mission Inn was the scene of the annual Conference, with an attendance of 423. Former International president Charlie Wheeler of San Francisco delivered his renowned talk on "Employer and Employee Relationships," and Edd E. McLaughlin of Texas was the International president's representative. Although the social aspects of the Conference were heightened by the delightful setting in the Valley of the Moon, the fellowship actually was a stimulus to the theme of the Conference, which emphasized the importance of better understanding between all peoples and nations of the world.

A major policy action taken at the Conference was the establishment of the nominating committee procedure of selecting the district governor, which continued from that time on.

Two Assemblies for new officers were held in June and July 1946. Fifty-four representatives



of clubs from San Francisco north met at Hoberg's resort on June 11 and 12, and 47 from southern clubs of the district met at San Jose on July 18 and 19, 1946. Each of these sessions was a business meeting, devoted to the indoctrination of new officers. Former district governors presented practical ideas, as individuals or as members of panels, with adequate time for questions by the incoming club officers after each presentation. As a businessman, Joe ran the district in the black and returned to the clubs a refund from their per capita contributions at the end of the year.

Joe Gabriel's concern for well-rounded clubs and club activities was evident in the scope of the suggestions he urged clubs to follow during the year: recognize the men returning from war service and assist them to find jobs or to enter business, invite worthy young men into Rotary to balance the age in clubs, and have a midyear club Assembly to analyze progress and plan for the remainder of the year. That these suggestions were not only listened to but carried out was a tribute to the governor during the 1945-46 year.

## CLARENCE C. PRICE

1946 - 1947

In 1946-47 Clarence C. Price took temporary leave from his long service as secretary of the Rotary Club of Vallejo to lead the district. Holding the classification music education, he was usually found at the piano during singing at club and district functions.

Sincere, serious, and efficient, Clarence emphasized the responsibility of club presidents during the year. His was a "working" year, devoted to expressing the theme of the International president, "Living in Friendship and Understanding."



2400 Rotarians were members of the 34 clubs of District 104 at the beginning of the 1946-47 year. By the addition of three new clubs and growth within the district, at the end of the year there were 2616 members.

As in previous years the district achieved an enviable attendance record, having approximately a 90% average for the year. Outstanding clubs in attendance were Beverly-Burbank, Garberville, San Bruno, Lakeport, San Anselmo, Sonoma, Arcata, Petaluma, Redwood City, and San Jose.

Sponsored by the Santa Clara Rotary Club, with William Hayward and G. F. Bacon as the governor's special representatives, the Rotary Club of Beverly-Burbank was chartered on October 28, 1946. The charter was presented to the 15 original members of the club at ceremonies held December 10, with past district governor Bob Rowe the featured speaker. Later to change its name to the Rotary Club of West San Jose, the Beverly-Burbank club immediately began a long tradition of leading the district in attendance.

Menlo Park, with 32 charter members, received its charter on January 21, 1947. Sponsored by the Rotary Club of Palo Alto, the governor's special representatives from that club were Gus Kirby, Bill Kratt, and Merrill Vanderpool. Bob Rowe was again the featured charter night speaker at the dinner held February 20 to honor the new club.

Under the sponsorship of the Rotary Club of Burlingame, the San Bruno Club was organized and chartered on March 27, 1947. Dr. Otis Callaway was the special representative of Governor Price. On April 10, 1947, the 15 charter members were honored at the chartering ceremonies at which Past District Governor Joe Gabriel was the main speaker.

On July 17 and 18, 1946, new club officers received their indoctrination in Vallejo at the district Assembly. Every new president was included among the 153 persons registered. Past governors and former International officers were present in full strength to participate in the Assembly, including Bob Rowe, Merv Hitchcock, Harry Mitchell, Joe Gabriel, Charlie Wheeler, Bru Brunnier, Herb Shuey, and the revered Paul Rieger in his final appearance at a district function.

Pat O'Hara was to have been the speaker at the Assembly luncheon, but was marooned by transportation difficulties and notice of his plight was not received until minutes before the speaker was to be introduced. Blair Tennent, a past governor from New Zealand was present, and stepped into the breach to give a most interesting account of his country and his impressions of the United States gained on a nationwide tour he was completing.

By far the most important occasion during the year was the holding of the 38th annual Convention of Rotary International in San Francisco in early June 1947. The annual Conference of District 104 was held in San Francisco on June 11 and 12, in conjunction with the Convention. President Richard Hedke of Detroit and incoming president Ken Guernsey of Jacksonville, Florida, were both in attendance at the Conference dinner. This occasion was featured as the "United Nations Dinner" with principal speakers from clubs in Great Britain, India, China, Brazil, and Peru.

Climaxed by an event which is the fortune of few districts -- the Convention of the Rotary World -- the 1946-47 year in District 104 was one of real accomplishment, reflecting the dedication of Clarence Price toward everything that affected Rotary and Rotarians.



## FRANK E. ALLEN

1947 - 1948

Friendly, gregarious, and possessing a lively sense of humor, Frank E. Allen brought a wealth of business experience to his leadership of the district in 1947-48.

Owner of a finance and loan company in Burlingame, and a 20-year member of the Burlingame Rotary Club, during World War II he served in many positions of executive responsibility in civilian war service.



Four new clubs were chartered during the 1947-48 year, and the membership of District 104 grew from 2599 to 2810.

Beverly-Burbank and Garberville Rotary clubs continued to lead the attendance parade as the district retained its position in the top ten in the USCB contest with a percentage for the year hovering around the 90 mark.

Under the sponsorship of the Rotary Club of Santa Clara, with Ken Hartman and "Bake" Bacon as the governor's representatives, the Rotary Club of Campbell with 17 charter members was admitted to Rotary on February 4, 1948.

On the same date the Rotary Club of Healdsburg was chartered. Frank Gori was the personal representative of Governor Allen, and with fellow members of the sponsoring club of Guerneville successfully formed the new club of 24 members. Shortly thereafter, the new club and Guerneville combined to present the annual canoe trip down the Russian River between the two communities, which became an outstanding day of Rotary fun and fellowship.

Sausalito became the 39th club of those in the present district as it was chartered on March 17, 1948. Sponsored by the Rotary Club of Mill Valley, the 17 charter members began an existence that became increasingly lively over the years.

On April 6, 1948, the Rotary Club of Willetts was chartered. Ukiah was the sponsoring club, and Don Ward the governor's representative.

Two significant events occurred during the year. For the first time a district-to-district project was undertaken with another country. Assigned to District 188 and specifically to the communities in the neighborhood of Rome, Italy, District 104 prepared and sent packages of clothing and food to assist in reducing the hardships resulting from the close of World War II.

Rotary Fellowships were instituted during the year as a project of the Rotary Foundation. Although only 18 Fellowships were awarded during the year, a strong impetus was given to the voluntary contributions in support of the Foundation, and the district became increasingly active in this avenue of International service.

On April 8-10 the annual Conference was held in Santa Cruz. With 598 persons in attendance, the Conference was abounding in fellowship. The piano duo of Christine Diener and Ruth Perry that graced meetings of the Santa Cruz club for a quarter century enlivened every meeting. This was a "singing" conference in every sense of the word. Tom Davis, past president of Rotary International, was the president's personal representative and featured speaker at the Conference.

175 club officers attended the Assembly at the beginning of the year. Held at Hoberg's on July 2-3, 1947, with the Rotary Club of Lakeport as host, past governors and the long-time San Jose secretary, Bill Wall, effectively indoctrinated the incoming officers. A number of significant actions were taken at the Assembly: A three-man District Finance Committee was established, having staggered terms so that one appointment would be made by each succeeding governor. A committee was appointed to make recommendations on the purchase of flags and decorations to become property of the district. By resolution, action was taken to present to each retiring governor a Past District

Governor's pin with a ruby set in the hub. A three-man committee appointed to investigate and make recommendations concerning a District Secretary filed a report against having a secretary.

International President Ken Guernsey set as his theme for the year "Solidarity Through Friendship." Under the leadership of Frank Allen, the 1947-48 year in District 104 expressed this theme within every club in the district.

## HAROLD D. BOSTOCK

1948 - 1949

An alert, enthusiastic banker from Santa Rosa led the district in its last year as number 104.

Harold D. Bostock brought to the district a wide background of participation in community business, cultural, and youth activities; and the year was devoted to extending the theme of the International president, "Developing Goodwill Among Men."



1948-49 was a year of great and varied activity in District 104. With 41 active clubs at the beginning of the year comprising a membership of 2803, two new clubs brought the membership to 2885 at the end.

A continued friendly spirit of competition helped maintain the high attendance record to which the district had become accustomed. Ranging from a low of 88.35 to a high of 92.98 per cent, the approximate percentage for the year was 90.88; and the district was consistently in the top ten. Outstanding clubs in attendance were Beverly-Burbank, with eight months of 100% attendance, Garberville, Campbell, Guerneville, San Carlos, San Bruno, San Jose, Burlingame, and Petaluma. In November the seven Sonoma County clubs resolved they were all going to appear in the first ten of the USCB contest and five of them did!

The territorial limits of the Rotary Club of Redwood City included the community of San Carlos. With the rapid growth of San Carlos, a group of Redwood City Rotarians felt it would be advantageous to start a new club. Accordingly, 15 members "seceded" and formed a provisional club. With Redwood City's Brooke Halsey acting as the governor's official representative, San Carlos was successfully chartered January 5, 1949. The charter was presented by Governor Harold at an appropriate ceremony on February 14.

In another split, the club including the communities of Mountain View and Los Altos determined that rapid-growing Los Altos could support a strong Rotary club. President John Whittlesey of the Mountain View club was the governor's official representative, and under the sponsorship of the Mountain View club the new Los Altos club was chartered on March 5, 1949.

Three former governors of the district were appointed to International committees during the year: Bru Brunner to the nominating committee for 1949-50, Frank Allen to the international extension committee, and Bob Rowe to the youth service committee. Stimulated by the latter's interest, on September 7, 1948, a Rotary youth conference was held in San Francisco. Thought to be the first of its kind to be held in the United States, the conference featured an appearance by Angus Mitchell, International President. Rotary participation in youth activities was the subject of presentations, including obligation to the handicapped, Rotary clubs in youth work, combating juvenile delinquency, and organizing boys clubs in the community.

During the 1947-48 year, projects resulting from the stimulus gained at the youth conference included the building of a boy scout house by the Rotary Club of Los Gatos, a similar project by the Rotary Club of Cloverdale, the development of a youth center building in San Bruno. With the assistance of the San Mateo club a youth activity was initiated which attracted over 400 youths to an auxiliary police club that met in a large basement equipped for recreational activities.

The Hollister club organized a crippled children's unit of San Benito County, the Watsonville club joined with the Kiwanis Club to erect a boy scout house, Lakeport completed construction of new tennis courts in the city park, the Burlingame club established a comprehensive youth vocational guidance program, and Palo Alto added a boy's day at the airport to its services in boy scout, junior baseball, and high school vocational day projects. Arcata led a community effort to raise funds for new uniforms for the school band, and the Santa Clara club was instrumental in having prominent traffic signs put up along highways used regularly by school buses.



Preceding the start of the year, the district Assembly was held on June 18-19, 1948, at the Sonoma Mission Inn with 260 in attendance. In addition to presentations by past governors, the resources of many outstanding Rotarians in the district clubs were used. Among those participating were Bill Williams of San Jose, Dr. Harvey Campbell of Santa Rosa, Bill Wall of San Jose, Ed Whitney of San Francisco, and Harold Meyer of San Francisco. Dr. Lynn White of the San Francisco Theological Seminary gave an inspirational address, "Four Faiths for Four Freedoms."

Although it had been used earlier for smaller Rotary meetings, Hoberg's Resort was the site of the 1949 Conference on April 28-30, with the Rotary Club of Lakeport as host club. Phillip Lovejoy, former secretary of Rotary International, was the president's personal representative. All but one of the clubs of the district were represented in the total registration of approximately 500. Hoberg's semi-isolation and rural atmosphere made it a delightful spot for a gathering, and the resulting friendship and fellowship was gratifying to all who participated. For the first time in the district, a Rotary Foundation Fellow appeared and spoke at the Conference. He was John M. Fraser from New Zealand.

Many meetings of note were held during the year, including a joint meeting of the seven Sonoma County clubs on September 8, honoring President Angus Mitchell of Australia. In August the Healdsburg and Cloverdale clubs held their first intercity meeting with Joe Gabriel as the inspiring speaker. In November the four Marin County clubs held a joint ladies night dinner meeting and a November intercity meeting with Guerneville and Healdsburg featured the British vice consul from San Francisco as speaker. And on November 9 the Rotary Club of San Francisco celebrated its 40th anniversary, paying honor to its founder and first president, Homer Wood. Past International President Tom Davis, of Butte, Montana, delivered the address of the day.

Although the district organized a selection committee and presented a candidate for a Rotary Foundation Fellowship, it was not awarded, but during the year many clubs took up the challenge to contribute, and achieved 100% voluntary participation.

District 104 closed out its identification with northern California on a high note of participation in a banner year. Rotary growth, projects, participation, and fellowship were all a tribute to the initiative and stimulating leadership of Harold Bostock.

## DISTRICT 155

1949 – 1957

(North Coast of California, including the counties of Del Norte, Humboldt, Lake, Sonoma, Napa, Marin, San Francisco, San Mateo, Santa Clara, Santa Cruz, San Benito; and the Rotary Club of Vallejo)

Renumbering did not affect the geographical area of the district during its eight years under the number 155.

Although one club was lost during the period, the district continued to grow, with 51 clubs active at the end of the 1956-57 year.

## HERBERT S. SHUEY

1949 - 1950

Herbert S. Shuey was the first governor of the newly designated District 155. A respected business leader and member of the Rotary Club of San Francisco, he was also deeply interested in cultural affairs. Following an extended trip to that continent, his colored slides presentation of Latin America was well received by large audiences, and had been a featured presentation of the district Conference in the Spring of 1949.

Herb's ability as an informal speaker, and his friendly personality and businesslike approach to problems of the district combined to make 1949-50 an effective Rotary year.



At the halfway mark in the 20th century, the theme "One World - The Century of Service" of President Percy Hodgson of Rhode Island focused attention on the service aspects of Rotary in District 155.

Although no new clubs were added, the district membership topped the 3000 mark as it grew from 2871 at the beginning to 3017 in June of 1950. Foreseeing a population surge in northern California, Governor Herb appointed a special committee to study the subject of Rotary expansion. Although the committee found that no new communities were yet ready for Rotary, its findings were to provide the groundwork for expansion that occurred later.

Attendance during the year continued high, with Beverly-Burbank, San Carlos, San Anselmo, and Guerneville clubs leading a parade that averaged over 90% for the year.

Community and vocational service was stressed, with many clubs extending their efforts into new fields. Some of the projects that were initiated or completed during the year included the promotion of new airports, erection of boys clubs, high school scholarships, attention to the handicapped and underprivileged, camperships, and boy scout and future farmer activities.

Clothing was sent to Europe by several clubs, many had programs dedicated to clubs in other countries, several clubs and many Rotarians carried on correspondence with Rotarians and clubs in other countries, and an increase was noted in club programs devoted to understanding of other countries of the world.

During the 1949-50 year clubs of the district contributed \$25,250 to the Rotary Foundation, and all clubs had at least a 100% rating by the end of the year. The first Rotary Foundation Fellowship was awarded to the district during the year, as Robert Butow, sponsored by the Rotary Club of Menlo Park, received a Rotary grant. Past Governor Harold Bostock was appointed to the Rotary Foundation Fellowship's regional committee of Rotary International by President Percy Hodgson during the year.

Past R.I. Director Porter Carswell of Georgia, was the representative of the International president at the district Conference. Held at the Palace Hotel in San Francisco April 21-22, 1950, local Rotarians were featured as speakers. With 1474 registered, this was the first Conference in northern California to exceed 1000. A highlight of the Conference was a magnificent concert given by the symphony orchestra of the Standard Oil Company of California.

The Rotary Club of San Mateo was host to the district Assembly held in San Mateo on July 8, 1949. With the ladies of Rotary specifically invited to participate, the total attendance approached 250. All clubs but two were represented and principal speakers were past International presidents Bru Brunnier and Charlie Wheeler; and past governors Joe Gabriel and Pat O'Hara.

Governor Herb checked with five International past presidents and took a strong advisory position as he counseled club presidents on the relationship of Rotary to other organizations. He pointed out



that, although individual Rotarians furnish leadership and provide contributions for worthy activities in every community, Rotary club funds should not be diverted to contributions for other organizations. He urged that club funds be used only for direct Rotary activities, those the clubs themselves had decided upon in community, vocational, or international service. This careful evaluation and resulting guidance to clubs of the district was but one example of a number of ways in which the leadership of Herb Shuey was felt effectively throughout the district during the year.

## WILLIAM E. WILLIAMS

1950 - 1951

The third San Jose Rotarian to become district governor was William E. "Bill" Williams, who served during the 1950-51 year. As Division Manager of the Pacific Telephone & Telegraph Company, Bill's many contacts throughout the district had given him an intimate knowledge of the Rotary communities in District 155.

Noted for his smile, Bill Williams was a friendly person with wide acquaintanceship whose warm personality made it easy for him to develop an intimacy of friendship and understanding. Though later transferred to Sacramento, he continued to maintain allegiance to the district and was called upon many times to serve at district functions.

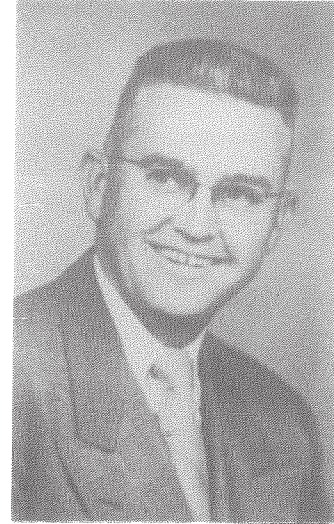

Although the Korean War was at its height, and 23 Rotary Clubs were closed in China, Rotary continued to thrive in District 155. Aided by the addition of two new clubs, total district membership increased from 2996 at the beginning to 3109 at the end of the year.

With the Rotary Club of Willits as sponsor, and Harold Robinson as the personal representative of Governor Bill, the Fort Bragg club was chartered with 25 members on October 25, 1950. And during the year for the first time the San Francisco club released territory, permitting the formation of a new club to its south. Under the sponsorship of the Rotary Club of Burlingame, South San Francisco was formed with 26 charter members on May 14, 1951.

An Assembly was held early in the year when the Rotary Club of Santa Rosa was host at a one-day meeting on July 14. With special activities for the ladies and all clubs of the district represented, the 358 registered got the district off to a flying start in the 1950-51 year.

On April 23-24, 1951, with the San Jose club as host, the district Conference was held at the Scottish Rite Temple in San Jose. All clubs but one were included in the registration of approximately 1100, which approached the record participation set the preceding year. Past director Roy J. Weaver of Denver, Colorado, was the personal representative of Quebec's International President Arthur Lagueux.

With the strong support and example set by Governor Bill's home club of San Jose, district participation in all forms of Rotary service was again high during the year. The smaller clubs of Campbell and Beverly-Burbank set high standards of attendance participation; and although many international service activities were related to the Korean War, youth and community activities continued strong in the clubs of District 155.

## BERNARD J. BUSH

1951 - 1952

Friendly, gregarious, ever dynamic Garberville was the home club of the 1951-52 governor, Bernard J. Bush. A retired retail druggist, Bernie led the district during the year that Bru Brunnier was president-elect of Rotary International.

Noted for his concern that the protocol and procedures of Rotary International be understood and adhered to, Bernie was an earnest, loquacious, and hard-working governor.

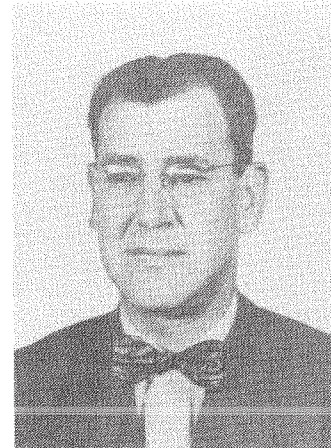

Facing up squarely to a problem that had been the bane of previous district governors, Bernie Bush recognized that the Rotary Club of Clear Lake Highlands was substandard. Semi-isolated from other clubs in the district, it had decreased in membership, failed to participate in Rotary or district affairs, and lacked potential for eventual success. After extensive discussion with Rotary International, the district petitioned to cancel the charter of the club, and on March 15, 1952, its charter was revoked and the Clear Lake Highlands Club went out of existence.

During the year the total number of clubs in the district remained at 45, however, because of the effective sponsorship of the Rotary Club of Milpitas by Santa Clara. With past governor Bake Bacon as the governor's representative, Milpitas was chartered June 5, 1952. The charter dinner was held on June 24, with past governor Bill Williams presenting the feature address to 22 charter members.

Exceeding a total membership of 3000 during the year for the first time, District 155 was found in the top ten of the USCB attendance contest every month of the year. Beverly-Burbank continued to lead in attendance, and received an award for this achievement at the district Conference.

Balanced interest in the four avenues of service was evident in club projects during the year. Because of the large number of summer visitors to its resort area, the Rotary Club of Guerneville developed and began a program of safety in recreational swimming and boating. This nationally recognized project was effective in reducing the annual number of drownings on the Russian River.

San Anselmo brought a steer to lunch at one of its meetings -- to be photographed, not eaten! Effective publicity was thus given to its youth achievement project, in which the club purchased a steer and turned it over to a selected boy to care for. Unusual recognition was given to the Rotary Club of San Francisco during the year in tribute to the service of the club number 2 as it acted for Rotary International in greeting visitors going through the Port of San Francisco. The Rotary clubs of Japan sent hand-crafted Rotary tie bars in appreciation to all members of the San Francisco club.

Preceding the start of the year, on June 24-26, 1951, the district Assembly was held in Vallejo, hosted by the Rotary Club of Vallejo. All clubs but one were represented among the 198 attending, and indoctrination of the new officers was carried out through the service of former governors.

Hoberg's was again the site of the district Conference. Held April 24-26, 1952, A. Z. Baker, a past director of Rotary International from Cleveland, was the personal representative of President Frank E. Spain. Major topics presented to the 553 attending revolved around the four-way test; with the highlight of the Conference a stirring address on international service entitled "Golden Strand" by former San Anselmo president Wallace Myers. The brilliance of the address catapulted Wally into district prominence and led to his nomination as governor a year later.

A formal resolution at the Conference established the rotation plan of the governorship followed thereafter. The San Francisco club was to present a nominee every fifth year, with the northern and southern portions of the district alternating in the other four years.

Over 300 persons attended a testimonial luncheon to president-elect Bru Brunnier in St. Helena



on June 24, 1952. Hosted jointly by the Rotary clubs of Napa, Vallejo, Calistoga, and St. Helena, the meeting was a rousing tribute to "Mr. Rotary" of the district as he prepared to take over the reins of leadership in Rotary International for the 1952-53 year.

## DR. WILLIAM OTIS CALLAWAY

1952 - 1953

A quiet, respected professional man led the district during the 1952-53 year. Dr. William Otis Callaway, charter member of the Rotary Club of Burlingame and long-time secretary of that club, served his profession in numerous executive capacities, including the presidency of the San Mateo County Medical Society.

Shortly after completing his year as governor, Otis Callaway entered the Jesuit Order and was ordained a priest in March of 1960.



Although Bru Brunnier was International president during 1952-53, the year in District 155 was less well documented than most.

No new clubs were added, with the number remaining constant at 45. During the year the total membership increased from 3158 to 3232. High attendance standards were maintained, with the district remaining in the top ten during the major portion of the year and attaining an over-all percentage of 93.26.

Past Governor Harold Bostock was appointed for a 2-year term on the finance committee of Rotary International, and Past Governor Bob Rowe was elected at the Paris Convention of 1953 to Director from Zone 1 for a two-year period.

Probably the outstanding club project for the year was completed by Santa Rosa as it raised \$9155 out of a total of \$11,470 obtained to construct a new boy scout house in the community.

San Mateo was the location of an Assembly meeting just prior to the start of the 1952-53 year. On June 26-27 former governors again led incoming club officers to an understanding of their jobs in the coming year.

In a departure from previous tradition, the district Conference was held in the fall, October 30-November 1, 1952, in Santa Cruz. Forty-one clubs were represented in the almost 600 registered who participated in the development of the Conference theme, "The Sixty-Four Dollar Question: WHY Am I a Rotarian?" (The "\$64 Question" was the top prize in an exciting radio quiz show current at the time.) Immediate past International President Frank Spain was President Brunnier's representative at the Conference and delivered two major addresses.

Two Assemblies were held in the Spring of 1953. The first was for clubs south of San Francisco and was held in San Mateo with the Rotary clubs of the peninsula as hosts. The second was held April 23-24 at Sonoma Mission Inn for clubs north of the Bay. All clubs but one were represented, and past governors and International officers participated in the indoctrination of incoming club officers and chairmen.

Even though the distance was great, a larger-than-usual number of District 155 Rotarians traveled to the 1953 International Convention. With Paris as the setting, it was presided over by Bru Brunnier, first governor of old District 13.

## WALLACE S. MYERS

1953 -- 1954

Wallace S. Myers of San Anselmo was governor during the 1953-54 year. An able trial lawyer, Wally was a forceful and articulate representative of his club and profession.

Thoroughly competent in all aspects of Rotary, his lively personality, quick sense of humor, and strong enthusiasm helped to extend acquaintance into lasting Rotary friendships. Wally's competence and dedication were later recognized by appointments to several R.I. committees and to special assignments by presidents of Rotary International.



Wally Myers emphasized the development of the individual Rotarian during 1953-54, and the many fine achievements that occurred during the year provided evidence that he was successful.

From a beginning district membership of 3215, the 3418 at the end showed a gain of more than 200. Three new clubs were formed during the year to continue the steady growth of Rotary extension.

Co-sponsored by the Rotary clubs of Arcata and Eureka, a provisional Rotary club was established in Crescent City on October 7. Following its successful chartering on November 24, a charter night ceremony honoring the 28 charter members was held on January 9. Bru Brunnier was the featured speaker and the 240 persons present included Rotarians from all parts of the district and from Oregon.

Under the direction of Jim Goodale, the governor's personal representative from the Rotary Club of San Rafael, the Novato club was chartered on April 26. All of the Marin and Sonoma clubs turned out in full force to welcome the new club into Rotary at the charter festivities the evening of May 22 when Governor Wally was the featured speaker.

The Rotary Club of South San Francisco, led by Lloyd Thorpe, its president and Governor Wally's special representative, sponsored a new club in Daly City. The application for membership arrived at the Seattle Convention, and wheels turned rapidly to admit the new club into membership in Rotary International. Chartered on June 8, the charter night ceremonies were held on June 26 in Stonestown.

Much attention was given to attendance during the year with the result that the district was in the top ten in the USCB contest all twelve months. Outstanding in attendance were the Rotary clubs of Beverly-Burbank, San Bruno, Sausalito, San Jose; and Wally's home club of San Anselmo had 26 consecutive 100% meetings. Rotary Foundation support was also strong during the year, with all but six clubs becoming 100% contributors by June of 1954.

Miss Joan Steindorf of San Mateo attended the University of Free Berlin as a Rotary Fellow from District 155. Three Fellows from other countries studied at Stanford during the year: Colin Haycroft from England, Trygve Ramberg from Norway, and Philippe Senat from France. Each visited many Rotary clubs during the year, and Trygve Ramberg also spoke at the International Convention at Seattle in June.

Approximately 600 Rotarians and guests participated in the annual Conference, held at Hoberg's in Lake County October 8-10, 1953. William R. Dowrey of Vancouver, B.C., past director of Rotary International, was the personal representative of President Joaquin Cibils at the Conference. Featured speakers included Clinton Duffy, former warden of San Quentin prison, Dr. T. L. Shen, former Chinese ambassador, Dr. Jesse Baird, President of the San Francisco Theological Seminary and honorary member of the Rotary Club of San Anselmo, and former governors and International officers of Rotary.

A playlet on club service, "Accepted with Regret," by members of the Rotary Club of Eureka was enthusiastically received. International directors Bru Brunnier and Bob Rowe were present



at the Conference, and informed Rotary International of the effectiveness of the Eureka skit. As a result, the playlet was filmed by Rotary International and its "world premiere" was a feature of the district Assembly the next spring.

Other outstanding service projects received recognition during the year. The Rotary Club of San Anselmo developed an information team that traveled to other clubs and presented an effective program on Rotary information. The Healdsburg club, with Rotarian Smitty Robinson as reporter, editor, and publisher, was mentioned in the Reader's Digest for December 1953, for the excellence of its "Rotary Hometown Newspaper" that was mailed to all servicemen around the world who were from Healdsburg. Many intercity meetings were held during the year, with the largest in Palo Alto on April 7 when the seven adjacent clubs of the Peninsula area gathered for an evening of fellowship. Many clubs made donations to Rotary clubs in India to help alleviate suffering from the rampaging floods that ravaged that country. And over 400 subscriptions of the Rotarian and Revista Rotaria were sent by clubs of the district to schools, libraries and communities in the district and in Spanish speaking countries.

A two-day Assembly was held April 30 and May 1, 1954, at Rickey's in Palo Alto. Sponsored by the Rotary Club of Sunnyvale, every club in the district was represented, with 100% participation of presidents-elect for the following year. The 324 persons registered participated in indoctrinating workshops led by past governors and outstanding club officers.

At the Hoberg Conference the program was dedicated: "To the individual Rotarian, to his continuing Rotary information, his fellowship, pleasure, and inspiration, as he seeks and follows the avenues of service." The same dedication could be applied to the 1953-54 Rotary year in District 155, as under the leadership of Wally Myers the district grew in service, numbers, and Rotary strength. Historically, it was an outstanding year.

## GOORKEN F. BACON

1954 - 1955

Known always as "Bake," Goorken F. Bacon of Santa Clara was governor during the 1954-55 year. His year was characterized by a deep concern for the individual Rotarian.

The high quality of club leadership developed during the year was directly related to Bake's personal magnetism and his keen ability to appraise and act on Rotary problems.

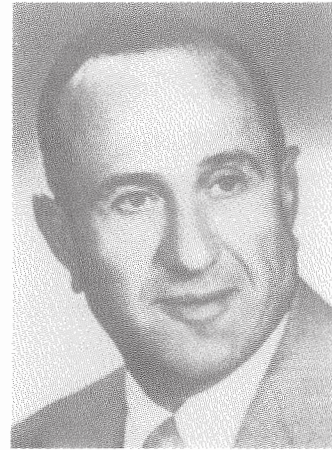

The golden anniversary of Rotary was celebrated throughout the year. Additionally, International President Herbert Taylor of Chicago emphasized the "Four-Way Test." This measure for evaluating plans, policies, and decisions was being widely adopted by business and professional executives, government officials, and educators, as well as all Rotarians in many parts of the world. President Herb was the author of the "Test," and thus, in addition to the golden anniversary theme, interest in promoting the four-way test gave great impetus to Rotary in District 155.

During the year Rotary International also embarked on a revised program of public information, whereby clubs and districts were encouraged to inform their communities about Rotary services and Rotary activities.

District attendance and district growth continued during the year. From approximately 3400 at the beginning of the year, the district membership increased to 3599 at the end, the first time the membership in the north coast area had exceeded 3500. This growth was assisted by the addition of two new clubs.

After a successful period as a provisional club, the Rotary Club of Cupertino was chartered on March 23, 1955. Don Hartman was Governor Bake's personal representative and the Sunnyvale club was sponsor. The 25 charter members were honored at the charter banquet held at Rickey's in Palo Alto the evening of May 14, 1955, when past governor Fred Lavelle was a special representative of Rotary International and the featured speaker.

With 20 charter members, the Rotary Club of Morgan Hill became the 50th club in the district on its chartering May 20, 1955. Francis Basch, President of the Gilroy club, was the governor's personal representative, and Gilroy was Morgan Hill's sponsor. The charter night was held at the Almaden Country Club on June 24, 1955. Charter president Vincent LeClair received gifts and congratulations from other clubs of the district as Morgan Hill began a sturdy existence.

Early in the year, Governor Bake, in addition to meeting with the clubs in his regular visits, arranged to meet club presidents in groups of four or five to further indoctrinate them and emphasize their leadership role in Rotary. Much of the local publicity given to Rotary in its 50th year was the result of these indoctrination meetings. The Vallejo club held a mammoth anniversary banquet on February 23, 1955, at which over 260 people were present. Each Vallejo past president and charter member was presented a parchment certificate of service signed by President Herb Taylor as well as club president George Chaffey. Much publicity to this event was given locally.

The San Jose Mercury-News of February 20, 1955, had a full-page spread commemorating the 50th year of Rotary. And on the occasion of the golden anniversary Conference, held in Santa Cruz in March, the Santa Cruz Sentinel-News had an 8-page supplement in color devoted to the golden anniversary of Rotary and to Rotary in Santa Cruz.

The golden anniversary Conference, held at Hotel Casa del Rey, attracted over 1000 Rotarians and guests. Dan Proctor, past governor and later International director, was the personal representative of International President Herb Taylor to the Conference. Governor Bake's home club of Santa Clara and the Santa Cruz clubs combined to host the Conference, which featured leadership by club presidents of small group discussions on various avenues of service.

Sonoma Mission Inn at Boyes Springs was the location of the golden anniversary Assembly, held

April 22-23, 1955. In excellent facilities provided by the home club of Sonoma Valley, incoming officers were indoctrinated in their duties by past governors and current club presidents.

“Bake” recalled with particular enthusiasm his visit to the 2-year-old club at Crescent City. The club Assembly on the occasion of his official visit was held in the afternoon, and during the meeting he asked whether the club was publishing a bulletin. Club president Gordon Weller replied that the club was not, but wished to know whether Bake wanted them to publish a bulletin. When Bake indicated it was desired, he was informed, “You shall have one!” At the meeting that night with the ladies at the hotel, a Rotarian came in with a huge bundle of fine club bulletins, complete with attractive masthead and informative articles. All of the creative work had been done and the first bulletin had been published within three hours.

Of course, Bake also recalled the tremendous Crescent City welcome accorded him when, as he came to the hotel, he found a large banner stretching across its front proclaiming, “Welcome District Governor ‘Bake’ Bacon.” As he was standing amazed at this hospitality, some high school students passing by were talking about the banner. One asked, “What’s that for?” to which the other replied, “Oh, some big shot has come to town!”

Governor Bake recognized that the economic situation was changing in the district and that the per capita contribution toward district support was insufficient. He worked carefully with the finance committee with the result that the per capita amount was increased for the following year and the district remained on a stable basis thereafter.

Rotary’s 50th anniversary year was strong in District 155, largely through the efforts of Bake Bacon as he encouraged club presidents to assume fully and strengthen their role as leaders in Rotary.



## E. W. STEPHENS

1955 - 1956

E. W. "Wick" Stephens was western director of the American Meat Institute. First a member of the Ukiah Rotary Club, he was a San Francisco Rotarian during the year 1955-56. His Rotary classification paralleled that of International President A. Z. Baker during the year, as "A. Z." was President of the American Stockyards Association.

Forceful, direct, and of high integrity, Wick had a fine facility for enlisting strong club support of all Rotary activities during the year.



Starting with 50 clubs and a membership of 3599, the year ended with 51 clubs and a total membership of 3771.

As usual the district was strong in its attendance record, with an average percentage for the year of over 93. Beverly-Burbank, Guerneville, San Bruno, and Redwood City were outstanding in attendance.

The last club to enter the district under its 155 designation was Saratoga. Sponsored by the Rotary Club of Los Gatos, with President Bill Mason as the governor's personal representative, the new club was chartered on December 21, 1955. All Santa Clara County clubs participated in sponsoring a gala evening when the charter was presented, as President A. Z. Baker was present in person to hand the charter to first Saratoga President Richard "Dusty" Rhodes.

Community service was highlighted during the year with most clubs continuing earlier activities and seeking new ones. Although not a new idea, Little League baseball activities began to surge during the year and many clubs followed the lead of the Rotary Club of Campbell in sponsoring Little League clubs.

When a midwinter flood inundated a large part of Santa Cruz, spontaneous aid poured in from clubs of the district. Administered by the Rotary Club of Santa Cruz, these contributions were used to complement the assistance provided by public agencies.

Rotary Institutes were inaugurated during 1955 as a planned training session for new club officers early in the year. Two Institutes were held early in the year, with Rotary extension counselor W. E. "Bill" Jansen of Roseville assisting Governor Wick. The Rotary Club of Burlingame hosted the first Institute held at the Elks Club in San Mateo. Ukiah was the site of the second Institute, hosted by the Rotary Club of that city.

Forty years of existence as a Rotary district were celebrated at the combined annual Assembly and Conference at the Palace Hotel in San Francisco on April 13-14, 1956. International President A. Z. Baker sent his personal representative Executive Secretary George Means. Developed from his vantage point, George's presentation to incoming presidents on the place of sub-leadership in Rotary was particularly effective; and his address to the Conference on future responsibilities in Rotary was excitingly challenging.

Robin Sharwood, Rotary Fellow from Melbourne, Australia, added to international understanding at the Conference by his presentation on the Rotary Foundation. The Burlingame club's sponsorship of a boy scout troop was given added meaning as an Eagle Scout award was presented during the Conference. During the memorial ceremony an extra note of sadness was felt by those who recalled his earlier devoted service to the district as the name of Paul Rieger was read.

Through his fiscal responsibility, Wick increased the reserve fund of the district almost \$3000 during the year and left it in a strong position. His year was remembered as one reflecting able leadership.

## GEORGE P. CHAFFEY

1956 - 1957

An able, dynamic school administrator from Vallejo led the district during the 1956-57 year.

George P. Chaffey was an excellent organizer and fine public speaker whose talents were recognized by Rotary International through several important assignments in succeeding years.

George succeeded well in personalizing the office of district governor; and this spirit was caught by the club presidents as they followed the theme of International President Gian Paolo Lang: "Toward Better Understanding in Rotary."

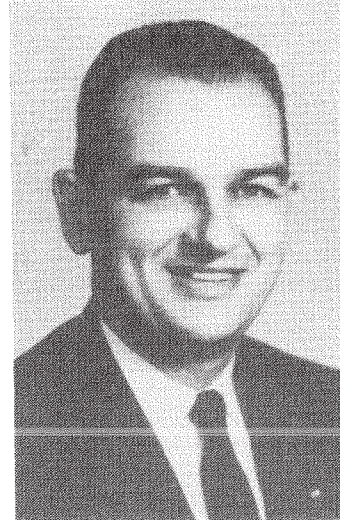

In its last year under the 155 number, the district added no new clubs, but membership in the 51 grew from 3772 at the start to 3879 at the end of the year. Four communities were surveyed, but it was determined that none were yet ready to support a Rotary club.

District attendance continued high with an approximate percentage of 93.02 for the year. During one of the months when the district percentage exceeded 94%, the competition was so keen that it did not place in the top ten of the USCB contest. Guerneville, San Anselmo, San Carlos, San Jose, and West San Jose were outstanding clubs in attendance. (Ending years of "Where is it?" confusion, during the year the Rotary Club of Beverly-Burbank officially changed its name to the Rotary Club of West San Jose.)

Two Institutes were held in November. Ukiah was host for clubs north of San Francisco on November 14, and Menlo Park for clubs from San Francisco and south on November 16. As Governor George had visited most of the clubs of the district by this time, it was planned to relate the training session for club officers to practical situations found in the district. The plan fell through, however, as George came down with the "flu" and was unable to attend. Past Governor Clarence Price took his place, and John English, an immediate past governor from Santa Monica, performed outstandingly as the Rotary information counselor for the district. A total of 134 Rotarians attended the Institutes.

Many contributions to Rotary service were made by clubs of the district during the year. Two-year-old Morgan Hill showed its youthful vigor under rather trying circumstances; on the day of the governor's visit it lost its secretary, two months later it lost its second secretary and president. In addition, the vice-president was hospitalized at this time and another member took over. Two months later, with a recovered vice-president as new president, the club had started a weekly bulletin, and had forwarded its check making it a 100% contributor to the Rotary Foundation.

The Rotary Club of San Mateo, always a strong supporter of youth activities, raised more than \$3000 for its youth scholarship program during the year. Vallejo inaugurated the tradition of honoring the outstanding high school honor graduates at a special ladies day luncheon. Continuing a long tradition of vocational service, Eureka sponsored a "Business and Professions Day" at which each member brought, upon his personal invitation, a guest who was engaged in the same or similar business activity. A day or two after the luncheon each Rotarian sent a personal letter of genuine friendship to his guest, with a Four-Way Test leaflet included.

Miss Patricia Henricus of San Francisco was selected as the district's nominee for Rotary Fellow to study in France for the 1957-58 year; and Mohan Chandri Joshi from India was a Fellow studying at Stanford. He spoke at many club meetings as well as at the district Conference. Over \$6000 was contributed to the Rotary Foundation by clubs of the district during the year, with Fortuna and San Anselmo becoming 300% contributors.

An important project of the year was carried out through personal contacts in Rotary. Two years earlier Viktor Straberger had been a Foundation Fellow at Stanford from his home in Wels, Austria. During his year in the district Viktor spoke to 27 Rotary clubs, and upon returning to Austria was



elected to Rotary membership. Following the communist take-over in Hungary, thousands of Hungarians fled to Austria and five refugee camps were set up in Viktor's home area of Wells. In personal letters to Governor George, he explained the urgent need and the readiness of Rotary to help the refugees. The appeal was met with contributions in excess of \$6000 sent from clubs in District 155 to the Rotary Club of Wells, Austria. Viktor Straberger provided a complete accounting of all funds received and of the expenditures made.

In April of 1957 Hoberg's was the setting for one of the longest district Conferences, extending four days in early April. Allin W. Dakin, third vice-president of Rotary International, was the personal representative of President Lang. His presence did much to assist in the Conference development of the three targets supporting President Paul's theme: (1) "Keep Rotary Simple," (2) "More Rotary in Rotarians," and (3) "Learn More About Each Other." All 51 clubs of the district were represented in the total registration of 627. Much recognition was given the 270 ladies present, including a presentation at the opening session by Mrs. Harold "Sis" Tucker of Garberville on "What Rotary Means to Me." An essay contest had been sponsored for the ladies and Lucile Sink of Cloverdale won first prize for her 150-word essay on "Why I Read the Rotary Magazine."

Five hundred persons at the Saturday luncheon participated in a dutch auction at which the Fortuna club demonstrated its ingenious method of raising funds for the Rotary Foundation. The \$170 raised was forwarded to the Foundation in the name of the district. Other highlights of the Conference included a dramatic presentation by the Rotary Club of Santa Rosa "The Verdict," Saratoga's panel, "A New Club Looks at Rotary," and sessions honoring oldtimers and new Rotarians.

A special resolution was passed at the Conference "authorizing the district governor to purchase, at his discretion, a suitable memento to be distributed to participating guests and officers of Rotary International."

All clubs participated in the divided Assembly held for incoming officers in May. Redwood City hosted southern clubs on May 23 in San Mateo, and Willits was host at the May 25 meeting in that city for clubs north of San Francisco. Former governors served as the indoctrinating faculty; and the sessions for secretaries-elect were assisted at San Mateo by Ed Whitney, secretary of San Francisco, and Fernando Minucciani, secretary of South San Francisco, and in Willits by Chal Crichton, Eureka's secretary, and Tay Sink, secretary of Cloverdale.

Breaking with tradition, Governor George did all his own typing and handled all correspondence himself during the year. Two examples of his personalized service were significant: he sent a personal letter to every man who became a Rotarian during the year, and after the district Conference sent a personal letter and a copy of the Conference program to the widow of each Rotarian who had died during the year. In addition to formal appointments to Rotary International assignments and committees, in later years George served as the personal representative of the International president at three district Conferences, addressed six different district Conferences, and addressed Rotary clubs of twelve districts in eight states.

Unlike most governors, George Chaffey was a salaried employee of a public agency. Much of his service to Rotary during the 1956-57 year was thus "on his own time." The record of successful achievement and forward progress in the last year of District 155 was thus a tribute to the sacrifice of a governor who tackled a job called "moonlighting" in school circles!

## **DISTRICT 513**

**1957 – 1970**

(North Coast of California, including the counties of Del Norte, Humboldt, Mendocino, Lake, Sonoma, Napa, Marin, San Francisco, San Mateo, Santa Clara, Santa Cruz, San Benito; and the Rotary Club of Vallejo)

Club growth, rather than district growth, characterized the first eight years of the district as 513. Retaining the same geographical area, three new clubs were added during the period, and total Rotary membership in the district exceeded 4000 as Rotary in the Redwood Empire prepared to enter its second half century of service.

**1970 –**

Redistricting resulted in the removal of the counties of Santa Clara, Santa Cruz and San Benito; and the Rotary Club of Vallejo from District 513. This left 42 clubs with 3239 members in the remaining counties of Del Norte, Humboldt, Mendocino, Lake, Sonoma, Napa, Marin, San Francisco and San Mateo. (For further details, see 1969-70 year.)



## MONROE E. BROWN

1957 - 1958

Owner of an insurance agency in Burlingame and a member of the Rotary club of that community, Monroe E. Brown (known best as "Brownie") was the first governor of the district under its current number, 513.

Business, Red Cross, international students, boy scouts -- Brownie was immersed deeply in each of these community activities in addition to Rotary.

One of the hardest working governors the district had, Brownie's gravelly voice will long be remembered as he exclaimed "Wonderful!" while encouraging others to work as devotedly as he in Rotary.



Rotary's president, Charles G. ("Buzz") Tennent from Asheville, North Carolina, stated as his theme; "Enlist - Extend - Explore - Serve." Throughout the 1957-58 year Brownie developed each of these charges in clubs of District 513.

As continued examination failed to uncover communities in which Rotary was ready to be formed, the 51 clubs remained constant during the year. An initial membership of 3836 grew to more than 3900 by June 1958 while the district attendance record continued high with an approximate percentage of 92 for the year. The San Bruno, Guerneville, Redwood City, West San Jose, and Novato clubs were outstanding in attendance.

An innovation in district organization was Brownie's assignment of chairmen and committees to offer district service in the four avenues of service. Mark Cotton, past president of the Menlo Park club, was the district chairman for club service. Roy M. Swain, of the Ukiah club, handled community service. Dr. Roy M. Laugesen, past president of the Mill Valley club, was in charge of vocational service; and Ernest A. Schepler, past Burlingame president, coordinated international service.

Former governor Clarence Price of Vallejo chaired a district committee concerned with the possibility of redistricting. The committee included Herb Shuey, Eureka president Oscar Olsen, Marty Franich, past president of Watsonville, and Jack Ewbanks, past president of Sunnyvale. The committee's report that the district was becoming unwieldy because of its geographical size and number of clubs brought no action from the redistricting committee of Rotary International. During this year George Chaffey served as Rotary information counselor for five districts.

As in most of the preceding years, Rotary's president chose to visit the Redwood Empire district. With all Rotary clubs of San Mateo County as co-hosts, the joint meeting at which Buzz was the featured speaker was one of the high spots of the year.

The 20th annual Conference of the district was held in San Jose on March 27-29, 1958. San Jose, as host club, was assisted by other clubs in Santa Clara County, as well as the governor's home club of Burlingame. A total registration just short of 1500 made this one of the most successful conferences to date. The program featured Rotarians of District 513 and adjoining districts, developing the theme "Rotary Fellowship." Past International president Estes Snedecor was the official representative for President Buzz Tennent.

Presentations and panels on each avenue of service were organized by the district committees functioning in these areas. Three Rotary Fellows in the district participated in both the Conference and Assembly that followed two months later. These were Bharat C. Dalal from India, Dr. Gerhard Sinzinger from Germany, and Hisayuki Nakamuta of Japan. A significant policy action passed at the Conference was to provide an allowance to enable the wife of the governor nominee to attend the Rotary International training assembly at Lake Placid.

Earlier in the year two Institutes were held for incoming club presidents and officers. Palo Alto was host to those representing clubs from San Francisco and south, and Healdsburg for the northern clubs. The total of 174 participants was reported by Rotary International as the largest attendance in 115 Institutes reported. Former governor and R.I. Director-nominee Richard L. Evans of Salt Lake City was the inspiring counselor assigned to the district for the Institutes by President Buzz.

On May 9-10, 1958, the Rotary Club of Santa Rosa hosted the annual Assembly at the Flamingo Hotel in Santa Rosa. Inspired by the presence of three Rotary Fellows (and 91 Rotary Anns), the past governors of the district did an outstanding job in assisting incoming officers to prepare for the following year.

Brownie summarized, "Wonderful fellowship and the wonderful cooperation of all clubs made 1957-58 a truly exceptional year."

## LLOYD C. HAYES

1958 - 1959

One of the younger Rotarians to be selected as governor, Lloyd C. Hayes was forthright, businesslike, and efficient in conducting the affairs of the district during 1958-59. A member of the Rotary Club of Sebastopol and partner in a funeral home in that city, Lloyd was the first governor to "shrink" the length of the district as he piloted his private plane on Rotary visits. His air mobility made it possible for Lloyd to initiate and carry out a new practice: that of making a second visit to clubs during the year.

During the year many of Lloyd's actions were directed to "Shape the Future," which was the theme of Rotary President Clifford A. Randall.



A new club was added during the 1958-59 year to bring the total to 52 in District 513, and the beginning membership of 3918 increased to a total of 3952. With an approximate percentage of 92.84 for the year, the district continued to maintain its strong attendance record in competition with other districts in the USCB.

In the Spring of 1959, through the interest of the Rotary Club of San Carlos, and particularly the governor's special representative, Bill Peppard of that club, a provisional Rotary club was organized in Belmont. Chartered on June 19, 1959, there were 26 Belmont charter members present at its installation banquet where Past Governor Wally Myers was the featured speaker.

Increased attention was given to district service to clubs, and an opportunity was provided for responsible Rotarians to grow in Rotary by a district organization that provided ten representatives to assist Governor Lloyd during the year. The past club presidents who served as area representatives were Oscar Olsen of Eureka, Norm DeLaittre of Cloverdale, Pierce Thompson of Petaluma, Jim Imrie, Jr., of Napa, Sam Knoles of San Anselmo, Adolph Holmes of San Bruno, Howard Imus of Redwood City, Reynolds Camp of Mountain View, Neal Royer of Campbell, and Bruce Jacobs of Gilroy. Each of these chairmen was instrumental in program development for the later Conference, Assembly, and Institutes.

Former governor George Chaffey was appointed to the three-member Constitution and **By-laws** committee of Rotary International for a two-year term. He chaired this important committee the following year.

As the number of Fellowships was increased, and an increasing number of Rotary Fellows were found in the district as club visitors and guests in Rotary homes, contributions surged in the district in support of the Rotary Foundation. By the end of June 1959 approximately \$62,000 had been contributed by all clubs of the district, with the Fortuna club at 500%, San Anselmo 400%, and seven other clubs over the 200% mark. The Rotary Club of Fortuna's annual Dutch Auction was to make it one of the leading contributors in all clubs of Rotary. A Rotary Fellowship was awarded during the year to Miss Patricia Gallagher of Menlo Park; and three Fellows were studying in the district during the year: Maurice Bazin from France, Geleyn Harold Jury from the Netherlands, and Erika Jansen from Germany.

Governor Lloyd also stimulated an interest in exchange students at the high school and college level. The district participated in preliminary work on Rotary organization for Visiting International Student Activities (VISA) that got underway in southern California; and in the high school exchange program sponsored by the American Field Service. Rotary Fellows and AFS representatives had a significant part in the program of the district Conference in the Spring of 1959.

In October 1958 on successive weekends at Morgan Hill and Cloverdale, two district Institutes were held to indoctrinate new club officers. All but two clubs were represented as information and extension counselor Frank Hornkohl, past governor from Bakersfield, led the meetings. It was at



Morgan Hill that Frank made the classic slip as he responded to a question about the classification principle that prohibited more than one Protestant clergyman in any club. A club president suggested from the floor that the situation was comparable to the banking business, in which an additional active member might be employed by the same firm but in a different bank. Hornkohl denied the situations were parallel because, "ministers don't work for the same boss."

The 21st annual Conference was held in Santa Rosa April 9-11, 1959, with the Rotary Club of Sebastopol as host. All events were held at the Flamingo Hotel, which was hardpressed to handle the total attendance which reached 1000. Returning to the district after his forceful leadership of the earlier Institutes, Frank Hornkohl was President Randall's personal representative. With a large number of Rotary Ann's present and much of the program provided by district and local talent, the Conference was extremely friendly and abounded in fellowship. Phil Robbins, long-time secretary of the Rotary Club of Santa Rosa, stole the show with his humorous and whimsical "needling" of club presidents as he spoke on "Lo, the Poor Secretary."

Watsonville hosted the annual Assembly, held May 8-9, 1959, at the Aptos Beach Inn. With 50 clubs represented and a total attendance of almost 200, presentations and panel discussions led by past governors effectively initiated incoming club officers on the mysteries of the coming year.

A highlight of the year was the celebration of 50 years of service by the San Francisco Club in November of 1958. International President Cliff Randall was present for the 2-day celebration, which included luncheon meetings, and a banquet and pageant.



DR. WALTER J. HAMILTON

1959 - 1960

District 513 continued in good health during the 1959-60 year under the ministrations of Dr. Walter J. Hamilton. Perceptive, cultured, a persuasive speaker, the warmth of his personality brought deepening friendships to Jim from throughout the Rotary world.

An avid fisherman, he was as well acquainted with the area and people of the northern part of the district as with Peninsula Rotarians and those of his home San Carlos club.



Although no new clubs were chartered, the total district membership at the end of the year had grown to exceed 4000, making District 513 the largest in membership in the United States, Canada, and Bermuda. As in the past the district attendance record was strong, with an approximate percentage for the year of 92.66. The district continued in contention in the top ten of the USCB attendance contest, led by the outstanding attendance records of Novato, San Anselmo, West San Jose, and others.

Many outstanding examples of Rotary service were evident during the year -- Cloverdale succeeded in lighting its softball field, Lakeport presented a Fourth of July boat parade on Clear Lake, Crescent City worked on the restoration of the Father Jonathan Memorial Cemetery, San Rafael developed a program of activities for senior citizens, Saratoga initiated an arts and craft show with the proceeds going to youth scholarships, a career day was put on in the high school by the Sebastopol club, Sausalito put resuscitubes in strategic spots along its beach, Morgan Hill gave 4-way test placards to be placed in school textbooks, Vallejo sponsored a courtesy contest; and San Jose, West San Jose, Sausalito, San Rafael, and Eureka developed Rotary contacts internationally in the sister city programs of those communities.

Following the precedent established by his predecessor, Governor Jim visited clubs a second time until an injury to his foot restricted his mobility. These visits accomplished much to stimulate clubs to complete programs and furnish continuity to the succeeding officers.

Inter-club and area meetings increased fellowship and community understanding on several occasions. With Hollister as host, the Morgan Hill, Gilroy, and Watsonville clubs held a testimonial dinner for past governor Joe Gabriel. San Carlos, Redwood City, and Menlo Park cooperated in a joint competitor relations luncheon. The Napa County clubs of Calistoga, St. Helena, and Napa attracted 300 persons to their annual rural urban dinner at the Calistoga fairgrounds.

In a whirlwind tour of the district, President Harold Thomas of New Zealand addressed three area meetings hosted by Healdsburg, Belmont, and San Francisco with a total of over 1500 Rotarians attending. Past governor George Chaffey represented Rotary International at the San Francisco Conference held during the year by the Institute for International Education.

Early in the year two Institutes were held for new club officers. Saratoga was host at the Villa Felice in Los Gatos for clubs south of San Francisco, and Garberville hosted the northern clubs. Past governor Ed Combatalade of District 519 was the Rotary information and extension counselor assigned by President Thomas, and the total attendance of 190 Rotarians established a new record for districts holding two Institutes.

All San Mateo County clubs joined as hosts of the annual Conference which was held at the Villa Hotel and the Fiesta Building in San Mateo. Past governor Bill Walk of Ontario, California, was the International President's representative at the Conference, which was structured around the theme "Rotary at Work." A number of innovations were found at the Conference -- a hall of displays of club bulletins, projects, and outstanding events; Conference awards to Calistoga and Redwood City for the most improved bulletins and to the West San Jose club for attendance; and the redwood tree lapel emblem displayed at the Conference by the Santa Cruz club which was later to be distributed widely at the Miami Convention to make many friends for District 513.

On May 5-7, 1960, incoming officers gathered at Rickey's in Palo Alto for the district Assembly. With 275 in attendance, the entire San Jose club presented as a special feature a demonstration of its organization meeting held annually at the beginning of the Rotary year. The first annual district directory of clubs and club officers had been printed and was distributed to incoming officers at the Assembly. Past district governors served as "faculty" at the Assembly, presenting brief discussions on the function of various officers and club committees, and serving as leaders of discussion work groups where questions and problems were answered.

During the year interest continued strong in the Rotary Foundation and approximately \$6000 was contributed by clubs of the district. There were five Rotary Fellows studying in the district, four at Stanford and one at the University of San Francisco. A district VISA committee headed by Monroe Brown explored ways and means of assisting international visiting students studying at institutions in the district.

Jim recalled with a chuckle his visit to one club; chatting with a member before the meeting, the Rotarian asked Jim to leave early with him because he'd heard the district governor was addressing the club and he just couldn't stand the so and so!

President Thomas' theme for the year of "Vitalize, Personalize, Build Bridges of Friendship" typified the attitude and role of leadership of Jim Hamilton. 1959-60 was a warm year, with much participation by all clubs and a feeling of over-all oneness.

## FRANCIS E. WHITMER

1960 - 1961

A banker and member of the Rotary Club of San Francisco, Francis E. Whitmer was a brilliant, cultured, quiet person who possessed great humility. An excellent organizer and fine speaker, he had a thorough understanding of the principles and workings of Rotary.

Fran's untimely death on September 20, 1960, lost to the district and Rotary a man of high potential leadership.

Immediate past district governor Jim Hamilton was elected by the Board of Directors of Rotary International to serve as district governor during the remainder of the 1960-61 year.

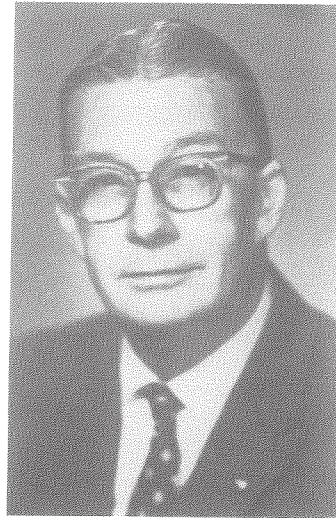

At the time of his death Fran Whitmer had organized the Rotary year and had visited 41 of the 52 clubs in the district. The smooth continuity that characterized district operations for the remainder of the year was a tribute to organization, continued support by Fran's home club of San Francisco, traditional strength of all clubs in the district, and the prompt rallying of former governors to Jim Hamilton's assistance.

Direction of district activities was decentralized by Jim, and club cooperation made the arrangement effective.

Lloyd Hayes handled attendance reporting in the district and made club visitations in some of the northern areas.

Harold Bostock became district treasurer.

Monroe Brown was in charge of the district Conference.

Wick Stephens was in charge of the Assembly that was combined with the district Conference.

While producing the governor's monthly letter, Jim relied heavily on guest editorials by former governors, and much material presented by clubs of the district.

Although no new clubs were chartered during the year, the 52 continued to grow in attendance. The total district membership at the start of the year of 4048 grew to 4154 at its end. The district attendance record continued high with an approximate percentage of over 92 for the year, with Guerneville, West San Jose, and Novato leading San Anselmo most of the year.

Club projects continued to be many and varied:

New mast-heads appeared in the format of the bulletins of Milpitas, Sonoma, West San Jose, Vallejo, and Mill Valley. Los Altos held a series of fireside meetings devoted to chapters of the Rotary book "Seven Paths to Peace." Lakeport constructed redwood planters for street decorations in the city, Fortuna conducted a traffic safety check, Fort Bragg initiated musical scholarships, Vallejo completed a children's wonderland playground through leadership of other agencies in the community.

The five Marin County clubs erected a rifle range for boy scouts, Ukiah erected a community barbecue pit, and West San Jose sent 3-member friendship teams to visit all other clubs in Santa Clara County to invite them to visit the West San Jose club. Santa Rosa gave leadership and sponsorship to Future Farmers, Daly City presented a VISA program for English teachers from other lands studying at San Francisco State College, San Rafael stimulated the application of the 4-way test in government, and the parole advisory committee functioning in the Watsonville club brought increasing commendation and interest.



Following a major earthquake in Chile, Sausalito and San Carlos clubs spearheaded drives to send drugs to that country; Fortuna shipped heifers to the orient to improve the livestock industry through Rotary, Redwood City began an international tree exchange, Menlo Park sent Christmas cards to Rotary clubs overseas.

Visiting International Student Activities (VISA) were given impetus by the district committee. Chaired by past governor Brownie Brown, the members were Norman Corlett of San Francisco, Walter Warren of Arcata, Ellis Howard of Santa Clara, and Leland Levinger of the Santa Rosa club.

Three Rotary Fellows were studying in the district, one at the UC Medical Center and two at Stanford. Theodore R. Marmor of Palo Alto was selected as a Rotary Fellow for the 1961-62 year; and under chairman Merv Hitchcock, past governor from San Mateo, the district increased by \$12,000 its contributions to the Rotary Foundation. Many clubs made contributions in memory of Fran Whitmer and the all-time contributions in the district topped the \$82,000 mark. The Rotary Club of Fortuna continued to lead, as an 800% club.

San Jose hosted the statewide Rotary bowling tournament in February of 1961 with nine of the ten California-Nevada districts participating. All Santa Clara County clubs participated in an inter-club meeting at West San Jose. San Francisco was host to its neighbors, Daly City, San Bruno, and South San Francisco at an area meeting.

Because mailing of promotional material was delayed by Fran Whitmer's death, the district institutes in September were less well attended than in former years. On October 13 the Calistoga club was host to officers of the clubs north of San Francisco, and on the 27th Sunnyvale sponsored the southern half of the district. Counselor Eugene W. Rideout, past governor of District 516, assisted Chairman Lloyd Hayes in Calistoga and Governor Jim in Sunnyvale.

A rewarding district project centered around the Tokyo site of the 1961 International Convention. Recognizing that Rotarians from the United States and many other countries would be passing through the San Francisco International Airport enroute to Tokyo, ten weekday Rotary luncheons were held at the Hilton Inn at the airport. Nine San Mateo County clubs, San Rafael, and Mountain View cooperated in holding regular meetings during the two weeks preceding the Convention; and also manned a Rotary hospitality booth at the airport. Publicity was given to this project both in the Rotarian and in the general secretary's news letter.

Sebastopol seized a unique opportunity and held a dinner honoring Rotary International officers and their ladies on May 12. Enroute to Tokyo, International President Edd and Pearle McLaughlin, President-elect Joe and Eula Abey, International Secretary George and Martha Means, and President-nominee Nitish Laharry were all honored at one of the most outstanding dinner occasions ever held in the district.

For the first time in many years the district had a candidate for Director of Rotary International, as past governor Wally Myers of San Anselmo ran second in the balloting at Tokyo.

A district-wide competition was held to select a theme for the combined district Assembly and Conference in San Francisco. The theme "Live Each Day the Rotary Way" was carried out during the April 19-21 meetings at the Sheraton Palace Hotel. Over 800 attended the combined event that featured First Vice-President A.D.G. Stewart from Sydney, Australia, as personal representative of President Edd.

From a leadership viewpoint the district emerged from a great loss to great leadership in 1960-61, and from a service viewpoint sought and accepted opportunities that brought great rewards and focused the eyes of the Rotary world on District 513.



## NORMAN C. DeLAITTRE

1961 - 1962

A quiet, friendly, diplomatic lumber manufacturer from Cloverdale led the district during the 1961-62 year. Norman C. DeLaittre was a Rotarian of considerable stature in his business and an extremely active member of the Cloverdale community.

Norm's background and training as an accountant served the district well in its fiscal procedures and in its records. His perceptive humility led many clubs of the district to consider and undertake projects they had hitherto considered beyond their capacity, and the result was a year of great Rotary progress under leadership that at times seemed almost unobtrusive.



International President Joseph Abey set as his theme for the 1961-62 year "ACT" - Aim for action, Communicate for understanding, Test for leadership. This slogan was carried out in many ways during the year, at both the club and district level.

For Governor Norm, the year was one of continuing and constant challenge. He was challenged to encourage many clubs to pull out of an unexplainable slump in Rotary participation and activities; to encourage club growth during a year when many declined in membership during the greater portion; to battle constantly with a printer to meet publishing deadlines; and to recover his own personal effectiveness after a period of hospitalization for ulcer treatment at midyear. That the district emerged at the end of the year in good shape was a tribute to the fighting qualities of Norm DeLaittre.

No new clubs were added during the year and total membership increased from 4154 to 4192 during this first year in which it had continually exceeded the 4100 mark. An attendance percentage for the year approximating 92 was remarkable in that it reflected some lean months and some very strong ones, during which a number of clubs were found consistently in the top ten of their divisions in the USCB contest. These included Guerneville, Sebastopol, West San Jose, Novato, San Jose, San Anselmo and Arcata. The district was in the top ten during more than half of the year.

Much attention was given to support of the Rotary Foundation during the year, with the result that ten clubs moved into the 200% or higher contributor class during the year, and the total contributions exceeded \$8000.

In the Fall, Ted Marmor, a candidate from the Rotary Club of Palo Alto, started his Rotary Fellowship year at Oxford; and two students from other countries were studying at institutions in the district. Miss Harriet Stenlund of Sweden was enrolled at the University of California Medical Center in San Francisco, and Carl Hoffman of Australia was a Stanford student. Both of these students made many appearances at clubs in the district, and were featured at the district Conference. In the spring, Donald V. Doub, Jr., a nominee of the San Francisco club, was selected for a Fellowship from the district for the 1963-64 year.

Two Institutes were held in September to help new club officers to effective leadership during the year. Well attended, they were held at San Mateo on September 16 and at Cloverdale on the 30th. John Dalton, past governor from Bellflower, was the Information and Extension Counselor assigned by President Joe. His effective and dynamic leadership was much appreciated, and he was invited by Governor Norm to return and participate later in the district Conference.

The 24th annual Conference was held April 5-7 at the Flamingo Hotel in Santa Rosa, with the Cloverdale club as host. Doane Farr, chairman of the 1962 Los Angeles Convention, and past director of Rotary International, was the president's personal representative to the Conference. In a friendly and relaxed atmosphere, the 1000 attending taxed the capacity of the hotel on many occasions. A well-received demonstration by the Fortuna club of its dutch auction netted \$180 for the Rotary Foundation in 10 minutes; a panel of club presidents led a stimulating discussion on club service;

President Frank Degan of Watsonville gave a brilliant presentation on Rotary and world peace, Stanford's Dr. Rixford Synder told of educational challenges in Africa, and Doane Farr and John Dalton gave outstanding presentations.

Governor Norm's small stature was the butt of a musical debunking skit devised by past governor Jim Hamilton. In a parody of a song popular at the time, "Big John," the 120-voice chorus of the San Carlos high school boomed out a taped message that assured all that "Big Norm" was nearing the end of his year of service.

With the Vallejo club as host, the annual Assembly was held May 11 and 12 at the Casa de Vallejo. With 100% club representation, incoming officers were well indoctrinated into the duties of their year. A feature presentation was that given by President Bob McConnell of Mill Valley who spoke on "If I were starting now."

Much interest was given to the first international Convention to be held in California in 15 years. In early June, Los Angeles was the setting for the largest Convention held to that time, and many Rotarians of District 513 were present. District 513 was host to the attending Rotarians from the southern states at the Dixie dinner. Past governor Joe Gabriel gave the keynote address before the 700 present, and his stirring talk on the privilege of being an American was one of the high spots of the Convention.

Governor Norm closed his year by encouraging clubs to be businesslike in submitting an audit of their finances for the year as a basis for the development of a workable budget for the next. In addition, he spent many hours in organizing the files of the district and reassembling them in a useful and workable form. Norm DeLaittre faced many challenges during the year and at its end District 513 was on the upswing, strongly participating in all avenues of service.



## DR. PERCIVAL M. BLISS

1962 - 1963

A junior college dean from the West San Jose club and former San Anselmo Rotarian was governor of District 513 during the 1962-63 year. Dr. Percival M. Bliss also responded to the title of Colonel (in the Army Reserve), and was a sports car enthusiast who pushed his Porsche 20,000 miles around the district during the year.

A forceful speaker, Perc used his dry sense of humor to spark creative attitudes in club officers of the district. His spritely monthly letters emphasized the theme of Nitish Laharry, Rotary's first president from India, who said, "Kindle the Spark Within" to strengthen Rotary service.

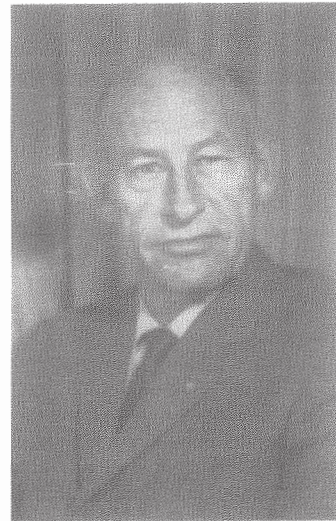

From a total beginning district membership of 4192, the district grew to 4245 at the end of the year, as it also grew by one club to 53.

Sponsored jointly by the Rotary clubs of San Bruno and Daly City, with past governor Brownie Brown as the governor's representative, the Rotary Club of Pacifica was chartered on September 13, 1962, with 25 charter members. The charter night festivities were held on October 12 with Governor Perc as the featured speaker. The baby club got its feet wet in service immediately, as the charter night's howling rainstorm flooded many parts of the area and the club turned out 100% the next day to help clean up the mess. The attractive masthead and excellent format of Pacifica's bulletin, "Whirling Currents," immediately proved to other clubs of the district that the new club was ably guided by Bob Fizer, its charter president.

The district continued to score well in USCB attendance competition, ranking in the top ten for ten months of the year with an average percentage of approximately 92. As in preceding years, Guerneville, West San Jose, Arcata, and San Anselmo vied for the top position; with Sebastopol, Fort Bragg, Lakeport, San Jose, Los Gatos, and Novato consistently found in the top ten.

Many creative and worthwhile projects were initiated and carried out by clubs of the district during the year. West San Jose gave an attractive silk banner to the district, "Home Club of District Governor," which began its appropriate annual rotation at the end of the year. With much sweat, Sausalito completed a participation project by which the members removed large boulders and made more attractive the city's recreational beach. Crescent City, after years of effort, completed the restoration of the cemetery named in honor of the foundered vessel, "Father Jonathan."

Now firmly established, Burlingame's welcoming and follow-through activity with visiting foreign students at the College of San Mateo was increasingly recognized as a fine example of an International service activity within the community. San Carlos established International contacts through Rotary as it sought items to be sold as its "Junktique Auction." Many clubs cooperated in the promotion of the K.O. polio drive sponsored by the medical association. San Mateo members were called at random at the luncheon meeting to describe their vocation in two minutes, and the rural-urban night of the Napa Valley clubs was the biggest ever in May of 1962.

INTERACT was born during the year, and an alert Vallejo club chartered the first INTERACT group in the western United States and third in all of Rotary at Hogan High School in Vallejo.

Rotary Foundation support and information grew under the able leadership of district chairman Bob Johnson of Morgan Hill. Over \$12,000 was contributed by clubs as the district's total contributions topped the \$100,000 mark. Fortuna achieved 1100% participation and San Anselmo, Garberville, and Fort Bragg became 500% clubs. The district gained its first former Rotary Fellow as Scott Thompson was elected to membership in the Cupertino club during the year. And three current Fellows and eleven alumni Fellows participated in the district Conference in April 1962.



Many noteworthy interclub and area meetings were held during the year. Arcata began a home and home visit with the Kamloops Club of British Columbia. Fort Bragg and Garberville exchanged lively meetings. San Francisco had interclub meetings with Oakland, Sacramento, Los Angeles, and Honolulu. West San Jose had an anniversary luncheon hosting all Santa Clara County clubs, with Bru Brunnier as the featured speaker. A confusing exchange was held between Lakeport and Ukiah. The presidents (Bill Jones and Merle Orchard) whose clubs met on the same day, arranged it secretly. Bill showed up with a program and presided at Ukiah, while Merle did the same at Lakeport!

Two Institutes were held in September on successive weekends. The Cupertino club hosted the southern half of the district at Foothill College, and Fort Bragg did the same the following weekend for clubs of the northern half. Ed Pitcher, executive secretary of the Oakland Rotary Club and past governor, was the Rotary information counselor at both sessions. Over 150 club officers and directors attended the Institutes.

Chaired by past president Bob McConnell of Mill Valley, the district VISA committee surveyed all clubs of the district to identify the activities they carried on with international students. The committee recommended that the district give greater attention to strengthen activities of its own clubs before engaging in extensive participation with the newly formed VISA, Incorporated, organization in southern California districts.

All Santa Clara County clubs participated in putting on the district Conference held April 18-20, 1963. With the exotic new Cabana Motor Hotel in Palo Alto as headquarters, and activities carried on there and at Rickey's across the street, 1350 registrants participated in a friendly and informative series of functions. Former director, and third vice-president of Rotary International, Richard Evans of Salt Lake City was President Nitish Laharry's personal representative. His masterful and inspiring talks and the friendly charm of Alice Evans endeared the couple to the Conference. A Silver Anniversary theme was carried throughout the two days, as this was the 25th Conference to be held in the geographical area of District 513. "Focus on Rotary" was the Conference slogan, aptly carried out by the leadership team of past presidents Jim Pasquali of West San Jose, chairman; Walt Borchers, San Jose; Jack Power, Palo Alto; and Conference treasurer Ellis Howard of Santa Clara.

Dr. Weldon (Hoot) Gibson, executive director of the Stanford Research Institute, was a featured speaker, sharing the spotlight with the fourteen Rotary Fellows and Alumni who were present during the entire Conference. A unique feature was two sessions where, in small groups under able leaders, Rotarians had an opportunity to discuss many aspects of Rotary for a 2-1/2 hour period without interruption.

Resolutions were passed at the Conference establishing a permanent rotating district VISA committee and endorsing the support of the VISA concept, establishing a rotating district Rotary Foundation committee, and the establishment of a committee to stimulate interclub projects.

During the year past governor Wally Myers was a member of the Rotary Foundation Fellowships committee, and Lloyd Hayes was on the vocational service committee of Rotary International. At the St. Louis convention, solid district support proved not enough as Wally Myers missed being elected director of Zone 1 by one vote on the fourth and final round of balloting.

Petaluma was host to the Assembly, held May 18 and 19. Its long layoff from hosting district events was not evident, as the Petaluma Rotarians proved friendly, efficient, and eager under the chairmanship of past president Nat Thompson. Typically, past governors provided great strength as the "faculty," carrying the heavy load of indoctrinating incoming officers and directors for the coming year.

1962-63 was a good year in Rotary District 513. But, as the 500 persons who assembled to honor President Laharry at Vallejo in October found, it was also a different year. The difference was in the challenge presented by the small brown man from Calcutta, as he urged Rotarians to seek with mind and heart intelligent ways to attain peace and understanding among nations of the world through attitudes of service.

## HAROLD E. TUCKER

1963 - 1964

Harold E. "Ted" Tucker, a Garberville realtor, was governor of District 513 during the 1963-64 year. As an individual he represented a cross section of all of the attributes of his home club: active, gregarious, informal, sports-loving, participating in a wide range of activities.

A former music teacher and master of many instruments, Ted was the leader and instigator of The Original Pistol River State Teachers College Dixieland Recording Band (Southern Division). The foot tapping music of this group was found at Rotary functions throughout the district over a number of years. Although its effect was the same, changing personnel over the years and a certain maturity brought many changes of name, until during the 1963-64 year its title had been simplified to "The Rotary Rhythm Rascals."

His long participation in district activities, and his wide acquaintanceship enabled Ted to make a strong personal impact on the district as it continued to grow during the year.



Although no new clubs were added, the 53 began with a total membership of 4192, and ended the year with 4351. While maintaining its position as the largest in total membership of all districts in the USCB, District 513 maintained a high over-all attendance percentage, exceeding 90% for the year. Guerneville, West San Jose, Lakeport, Sebastopol, Novato, Arcata and Los Gatos were found consistently in the high ten in attendance during the year; and the San Jose club continued to rank first or second among all clubs of its size in the USCB competition.

International President Carl Miller of Los Angeles expressed his theme for the year as "Rotary in the Space Age;" and began what was known as the Great Exchange. Under this plan districts of the world were paired with each other to extend understanding across continents. District 513, along with 516 and 522 in northern California, was paired with District 305 in India-Pakistan. This project required considerable leadership in the district and Governor Ted gave much attention to it during the year.

Early in the fall two Institutes were held, with L. A. "Bert" Bertagna of Carmichael as the International counselor. Clubs from San Francisco and south met in Santa Cruz on September 20, and those north of the Bay at Healdsburg on the 27th. One hundred and eighty-five club officers, directors, and committee chairmen participated in the indoctrination sessions.

Rotary Foundation activities received much support during the year as three Fellows were studying in the district: Walter Richter and Gilles Joseph C. A. Costa at Stanford, and Miss Grete Paulsen of Denmark. She attended San Jose State College as probably the last woman Fellow to be seen in the district, as the board of directors of Rotary International had determined that Fellowships would be open only to men in the future. As Fortuna maintained its 1100% participation in Foundation support, Garberville moved to 600% and South San Francisco joined San Anselmo in the 500% bracket. San Carlos gave \$120 in a successful project, \$5 each in the name of twenty foreign clubs. The district Foundation committee nominated Glen Moreno, a candidate submitted by the Rotary Club of Morgan Hill, for a Fellowship for the 1965-66 year.

As INTERACT clubs continued to be formed in Rotary communities around the world, Vallejo organized the second club of the district in another of its high schools, and new clubs were formed and sponsored by Fortuna, Campbell, and Garberville.



A number of club projects during the year were related to the Great Exchange. Menlo Park had the Pakistani consul general as a featured speaker at one of its meetings, Burlingame prepared and exchanged with its matching club in India an 8 millimeter color movie; while Santa Rosa did the same with colored slides and voice recordings on tape. Eureka set up sponsorship of a District 305 student to Humboldt State for a year. The Eureka club also gathered 3000 pounds of books and sent them to a brother club in Tanganyika.

In other club activities, Los Altos provided tuition for a year for a foreign student attending the University of California, San Carlos published an attractive history, following by a short period the one published by the Rotary Club of San Jose. San Jose, in turn, celebrated its 50th anniversary with Bru Brunnier pinch hitting for Joe Gabriel who had been invited to speak but became ill.

Clubs of the district rallied to the assistance of the community of Crescent City which was ravaged by a tidal wave just prior to Eastertime. Donations and contributions were sent to and handled by the Rotary Club of Crescent City to help the community realize the objective it posted on a large signboard at the entrance to the city, "Comeback Town, U.S.A."

Another example of Rotary strength was demonstrated by Guerneville as it continued its 100% attendance at meetings even though a fire burned down its meeting place.

For the first time in twenty years Eureka was host to a district Conference, as 926 Rotarians and their wives registered at the Eureka Inn April 30-May 2. Fine Chamber of Commerce planning was evident as the visitors arrived under sunny skies, but in the succeeding two days the normal rainy Eureka climate returned.

President Miller sent a fellow Los Angeles Rotarian, Don F. Warren, as his personal representative to the Conference. Although many of the participants who were unfamiliar with the Eureka area did not realize that the warm fellowship and hospitality were typical of the normal Eureka atmosphere, the consensus of all who attended was that the 1964 Conference set a new high for friendship and fellowship.

All INTERACT clubs of the district were represented at the Conference in a presentation by the high school youth, the three Rotary Fellows in the district were in continuous attendance and made fine presentations, and an exhibit of international projects by clubs of the district that was prepared by the Rotary Club of Morgan Hill. Two unusual events were also highlights. An earlier request from the Rotary Club of Perth, Australia, for representative dolls to be used to raise funds for its project had stimulated a district-wide competition. Fifty-six dolls were displayed at the Conference. These had been prepared by Rotary Anns in the district, who designed them to represent areas of the district from the Santa Clara County prunepicker, the little old winemaker of the Napa Valley, to the lumberman of the redwoods.

International dinners on the second night were held in three different areas, with the Fortuna, Eureka, and Arcata clubs hosting visitors from other parts of the district. Governor Ted and his party visited each dinner in turn. During the social hour preceding the governor's ball, Ted and the Rotary Rhythm Rascals set a lively tone for the evening with their dixieland music. Over half of those attending the Conference stayed over for the ranch style Sunday breakfast held at the historical Carson mansion in Eureka that had been maintained in all its Victorian glory by the Ingomar Club.

District activities for the year closed with the Assembly for incoming club officers held at the Sheraton Villa in San Mateo on April 10-11. With the Burlingame club as host, and past district governors as faculty, all clubs were represented, including 34 re-elected secretaries. At the Assembly the first annual Jim Hamilton award for the club bulletin that used most material from the governor's letter was awarded to the "Whirling Currents" of Pacifica.

The "Great Exchange" was the major district project for the year, with clubs increasingly in contact with, and participating in, interclub projects with their paired clubs in District 305. Reflecting the personality of Governor Ted, the year could be characterized as high in fellowship, participation, and action.



## STANLEY E. McCAFFREY

1964 - 1965

A handsome, gregarious, warmly personable San Franciscan was governor in the last year of the first half century of the district.

Stanley E. McCaffrey, as manager of the Bay Area Council had wide acquaintance in the communities of the district. A former president of the Rotary Club of Berkeley, Stan's experience in many and varied executive positions brought to the district leadership of nationally recognized stature. Alert to the changing nature of the times, and the increasing potential of Rotary's international impact, Stan's creative and forceful approach to advancement of clubs and district was a stimulus to continuing achievement in the district's Golden Anniversary year.

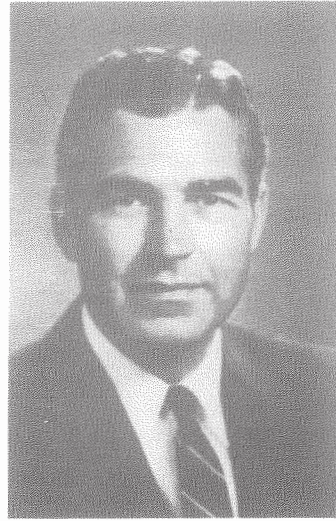

Rotary's Golden Anniversary year in the redwood empire district found leadership where it began-- in the Rotary Club of San Francisco. Between Bru in 1915 and Stan in 1965, 50 years had brought significant changes in district size, total membership, and Rotary direction. But the two governors had a common purpose: advancement of the strength and purposes of Rotary.

"Live Rotary" was the theme of the International President Charles Pettengill for the 1964-65 year. His theme was carried out in all aspects of service, growth, and cooperation in District 513 during the year.

A beginning membership of 4351 grew to over 4400 at midyear with an estimate of approximately 4500 at the end of the year. Thus the district continued to be the largest of all in the United States.

The district was in the top ten in the USCB contest four times in the first six months of the year. Outstanding clubs in attendance were Guerneville, San Bruno, West San Jose, Calistoga, Sebastopol, Novato, San Anselmo, and San Jose.

Sponsored by the Rotary Club of San Rafael, and under the direction of its past president, Jim Goodale, as the governor's personal representative, the Rotary Club of Terra Linda was chartered on July 25, 1964. At the charter banquet on August 1, the 25 charter members were welcomed into the district by Governor Stan as principal speaker. Under his direction, extension surveys were also made in eleven areas, with four becoming excellent prospects for new clubs in the district.

Ten areas were established in the district and governor Stan designated personal representatives to work with clubs in each of the areas. Twelve district-wide committees were also established to organize and stimulate Rotary service and projects. The effectiveness of the governor's representatives and the activities of the district committees kept club interest high during the year.

The district organization plan proved extremely effective in two disastrous occurrences during the year. In the Fall a sweeping fire spread from the Santa Rosa area through the northern part of the Napa Valley, and district contributions provided great assistance to the Calistoga and St. Helena clubs in Rotary service that complemented that of governmental and other agencies. At Christmas time severe floods occurred in the northern part of the district and the Eureka and Garberville clubs received and put to good use donations from clubs throughout the district and other parts of the Rotary world. Over \$10,000 was contributed for these purposes and clubs made an accounting to the district of the expenditure of the funds. It was anticipated that any amount remaining would provide for the establishment of a district disaster fund.

In the early Fall, two Institutes for club officers were held with the Belmont and Santa Rosa clubs as hosts. In a change from former procedure, Rotary International no longer designated a specific Information and Extension Counselor, but named former governors within the district to assist the governor in conducting the Institute. Past governors Perc Bliss, Brownie Brown, and Bill Williams

were designated as Institute "faculty" and addressed the record 250 in attendance.

Rotary Foundation interest and contributions continued high. Gideon Falk from Israel was a Rotary Fellow studying at Stanford University; and Glen Moreno of Morgan Hill began his Fellowship study in India.

Following a two-year study of the Rotary Foundation by Rotary International, two new Foundation programs were instituted; a group study exchange program was announced, which provided awards for an exchange of groups of young business and professional men between paired districts for two-month study periods; and a program of Fellowship awards for a year of training at technical institutions. District 513 submitted plans for participation in both programs and was commended by Rotary International for its presentations.

"The Great Exchange" project initiated in 1963-64 was continued during the year. In combination with adjacent districts 516 and 522, a memorable project was completed in service to the matching district 305 in India. Over 30,000 technical volumes and \$3000 were contributed in a "books and bucks" project to assist development of the Rotary Nehru Memorial Library at India's University of Indore. During the year many clubs had programs and speakers featuring the great exchange and our matching district 305.

High school Interact clubs continued to grow in the district with a jump from six to twelve at midyear, and a prospective additional six by the end of the year. The first district Interact conference was attended by over 200 Rotarians and high school Interact members. Held at Vallejo on January 30 under the general chairmanship of past governor George Chaffey, this activity drew special commendation from Rotary International and was complimented in the Rotarian magazine as an example for other districts to follow.

Club service activities continued to expand in varied avenues. In addition to disaster relief services some noteworthy projects were: Palo Alto and Los Altos working together with an underprivileged community in East Palo Alto to stimulate youth and community service; a job-training program developed for high school youth by Garberville; publication of a booklet to assist high school job seekers, "Get That Job," by Los Altos; a Santa Cruz project in cooperation with the local junior college in job counseling and providing job training opportunities; development of a motion picture of VISA activities by Redwood City; and the Marin County clubs' sponsorship of a first International Festival for foreign students. The San Francisco club introduced a novel feature in its introduction of visiting Rotarians from foreign countries by displaying the flag of his country as each individual was introduced. And as Phil Robbins retired as long-time secretary of the Santa Rosa club, Rotarians from all parts of the district attended a dinner honoring him.

In another RI policy change, the district Assembly was designated a responsibility of the incoming governor, to be held after his return from the International Assembly and Convention. The Assembly, combined with the Institute, was planned for mid-June 1965.

The golden anniversary Conference of district 513 was held at the Fairmont Hotel in San Francisco April 29-May 2, 1965. Honoring past RI president Bru Brunner, as founder of the district idea in Rotary, President Charlie's special representative was Kiyoshi "George" Togasaki, Rotary's second vice-president. In a departure from tradition, President Pettengill planned to fly in to honor Bru. Outstanding San Francisco Rotarians were featured as speakers, including Chief of Police Tom Cahill, restaurateur George Mardikian, and Rabbi Morris Goldstein.

Culminating a two-year study, a district legislation committee had recommended that all previous Conference resolutions be rescinded. An entire new set was prepared for submission at the Conference so the district could place its affairs in order.

District 513's golden anniversary year was one of growth, progress, excellent organization, and extension of the horizons of international service. It was a year of warm fellowship through Rotary, and one in which all Rotarians in the district were stimulated by Governor Stan McCaffrey's theme to "Meet Our Challenges Through Rotary."



## GEORGE A. STARBIRD

1965 - 1966

Native son of the Golden West, Stanford graduate ('32), former mayor of San Jose, recipient of numerous outstanding civic awards, partner in an old insurance firm (dating back to 1896), George Starbird brought stature to the leadership of District #513 in 1965-'66.

"SHARING ROTARY THROUGH ACTION" was the theme of his opening address. It inspired the 4500 Rotarians of District #513, largest district in Rotary International. In this address he pointed with pride to California living and to Rotary's opportunities in California's expansion. State problems then, according to Stanford Research Institute, were 1) urban sprawl; 2) traffic congestion; 3) air pollution; and 4) water shortage. The keynote of the year was expressed in his use of Jack London's 1915 quote: "The call is for service . . . he who serves all, best serves himself".



The following projects were pursued by the clubs of the district throughout the year. 1) MATCHING DISTRICTS. We were matched with District #305 of India. Later District #118 in Wales, and District #453 in Brazil were added. 2) GROUP STUDY STUDENT EXCHANGE. The district sent six unmarried non-Rotarian young men to Japan for from sixty to eighty days. 3) INTERACT, whose purpose is "to develop service and understanding among our high school boys." 4) FOUNDATION FELLOWS. Eight FELLOWS found homes within our district - one each from Brazil, Australia, Ireland, Mexico, Iceland, England, Argentina and Finland. 5) VISA, whose purpose "encompasses visiting international students at the junior college level . . . to acquaint them with life in America and especially home life".

The district governor's calendar for the year was a busy one. The district hosted INTERACT'S club delegates at Henry Gunn High School and at the Army-Stanford football game, October 23. Vallejo was chosen for the March, '67, annual Interact Conference.

The district hosted all of the twenty-five (25) district governors of the eleven western states (Zone #1) at Hyatt House, San Francisco International Airport on December 11th. PDG Stan McCaffery was chairman of the event.

Two new clubs were established during the year. Bayshore's charter night was held October 8th at Rickey's Hyatt House in Palo Alto. It was sponsored by the Palo Alto club. Millbrae was granted its charter on March 26th at the Hyatt House, Burlingame. Its sponsor was the Burlingame club.

During the year the district conference was held at San Jose, April 28 - 30th.

The Rotary International convention was held at Denver, June 12 - 16.

George had 100% perfect attendance from 1944 to the date of his district governorship - 21 years.

His philosophy is best expressed in the quotation which has come down to us through the ages: "We cannot choose the age we live in, so it is our duty to shape it to the best of our ability".



## STANLEY L. LANCE

1966 – 1967

Stanley L. Lance, member of the Santa Rosa club since 1947 and its president, '59-'60, was born in Eastern Washington on a wheat ranch. The only reason he is not a native of Sonoma County was because his father, an attorney, was involved in settling a family estate on the ranch and took his pregnant wife along. Returning to Sonoma County at six months of age, he attended elementary and high schools in Sebastopol, Santa Rosa Junior College, University of California (briefly following WWII) and the San Francisco College of Mortuary science.

During World War II he served as a fighter pilot for the U. S. Navy.



Having spent most of his life in the funeral service business, he has served as president of a number of professional societies, namely, the Redwood Empire Funeral Directors' Association and the California Funeral Director's Association.

A community-minded man he has served as chairman of a number of philanthropic organizations (Red Cross, American Cancer Society, March of Dimes, etc.) and headed up their financial campaigns. In 1954 he was named recipient of the Man of the Year Award in Santa Rosa.

His wife, Mary Ellen, a first grade teacher, and three children (two college sons and a high school daughter) comprised his family upon his taking office. Stan liked spectator sports (when his athlete sons participated), together with hunting, riding and tennis.

"Free-Lancing" became a term widely used in the district during his term of office. His enthusiasm and desire for action was manifested in a full club visitation schedule with only eleven dates open "for the governor's recuperation". When asked what his topic, or theme, for the year would be, he replied: LET'S HAVE FUN IN ROTARY". He really followed R. I. president Richard L. Evans' theme, "A BETTER WORLD THROUGH ROTARY". Each month the district news letter contained one of R. I. president's "Ten Things To Do". They were so important to D. G. Stan Lance that they are repeated here:

1. Share Rotary by adding new members.
2. Share Rotary by adding new clubs.
3. Enjoy Rotary Fellowship.
4. Discover and Serve the Needs of your Community.
5. Make your Business or Profession Better—Improve.
6. Serve Youth (Organize Interact Clubs).
7. Pursue Effective Public Relations.
8. Emphasize the Internationality of Rotary.
9. Engage in World Community Service.
10. Contribute to the Rotary Foundation.

That these aims and ideals were realized was evident in the growth of the district in membership – to 4727 members; by the chartering of new clubs - at East San Jose, and Mendocino, sponsored by the Milpitas and Fort Bragg clubs, respectively.

A new Rotary program, "Awards for Technical Training" was instituted in the district.

"Operation Adorable", where district #513 sent a native educational leader into San Leonardo, Nuva Ecija, a town of 1514 people located 103 kilometers north of Manila, received high praise from the district governor of District #380 in the Philippines, Rudolfo Nisce, who wrote: "You are helping the barrio man's fight against poverty, disease, ignorance, and civic inertia by underwriting this project".

The exchange of sons and daughters of district Rotarians with District #365 (Kyoto and Osaka, Japan) was urged.

A permanent type district secretary to handle the district's attendance contest and the mechanics of the district governors' news letter was urged.

The Pacifica club introduced the innovation of the use of a popular credit card in payment of luncheons, fines, dues, and contributions by members.

Appreciation was expressed by the district governor in his frequent bestowal of a "Rotary Rose" upon some individual for work well done, e.g., to PDG George Starbird for raising the number of Interact Clubs in the district from nine (9) to twenty-four (24).

During the year the annual Interact Conference was held at Hogan High School, Vallejo; a Zone #1, Regional Institute was held in Los Angeles, Dec. 9, 10; the District Conference at Flamingo Hotel, Santa Rosa, April 20-22; the District Assembly on May 13th at Foothill College in Mountain View; and the International Convention in Nice, France, May 21-22, with 112 reservations from #513.

Chosen to serve on the International Service Consultation Group, R. I., '67-'68, the only other member from the U. S. along with Past R. I. President Joseph A. Abey, of Pennsylvania, outgoing district governor Stan Lance reflected on the truth of the statement:

"The only time you say 'No' in Rotary is when they ask you if you have done enough".

## JACK B. POWER

1967 – 1968

JACK B. POWER, past president of his home club (Palo Alto) in 1961-'62, is one of that city's most prominent citizens. Member and chairman of the Board of Education, one time "Father of the Year", registered mechanical engineer, and now a business-man partner in a hotel chain, Jack had achieved prominence in Rotary before taking office as district-governor for 1967-'68.

Prior to taking office as club president he traveled around the world attending a Rotary Meeting every week. He attended the international convention in Tokyo. He was chairman of District #513's Group Study Exchange Committee ('65-'66) and was so successful in implementing this program that #513 became one of the first districts to have an exchange; further, #513 was immediately granted another for 1966. He was chairman of one district assembly in Palo Alto and helped organize the Bayshore (Palo Alto) Rotary Club in 1965.

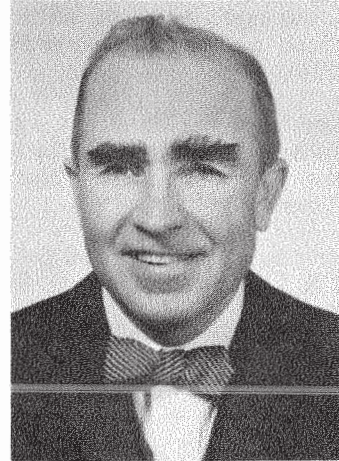

Married, father of three young adults, one of whom was married during his term of office, a WWII veteran of the 7th Armored Division (he entered service as a private and left with rank of major), Jack, together with his wife, Marge, completed official visits to all sixty clubs in the district by the end of the Thanksgiving season.

Encouraged and inspired through a monthly column in the district news letter entitled "HOT LINE FROM THE POWER HOUSE", #513 could number its accomplishments each month in somewhat the following manner:

- July - Bru Brunnier International Service Award inaugurated. Established in honor of H. J. "Bru" Brunnier, great Rotarian and former R. I. president, the committee's award was to go to that club in the district which was adjudged to have rendered the most significant international service during the year.
- Aug-Sept. - Arrival of an Australian Group Study Exchange Team for a sixty day visit.
- Oct. - New Leadership District Forums were held at College of Marin with five participants from each club. The agenda was focused on R. I. president Luther Hodges' program. These forums were attended by 197 persons from 52 of the district's sixty clubs. INTERACT WEEK was held Oct. 8-14th for the thirty-two INTERACT clubs in the district. More were to follow later in the year. Membership in the clubs was opened by R. I. to high school girls provided that half of any club's membership was boys.
- Nov. - District #513 won R. I.'s World Attendance Contest. In this contest, fifteen clubs or 25% of the district, had 100% attendance warranting a congratulatory phone call from R. I. headquarters in Chicago.
- Dec. - A "SIGNIFICANT ACHIEVEMENT AWARD COMMITTEE" was appointed with Ray Winther as chairman. At year's end the award was to go to the Rotary Club of Saratoga.
- Jan. - Reciprocal toasts to matching District #118 in England and Wales were carried out.
- Feb. - "JOE GABRIEL MEMBERSHIP AWARDS" went to five district members. To obtain this award at least three new Rotarians had to be secured by any individual Rotarian.
- March - The annual INTERACT CONFERENCE was held at Saratoga high school with the inauguration of a talent and display competition.
- April - The DISTRICT CONFERENCE was held in Palo Alto. Participating on the program as speakers were KCBS radio and TV personality, Rolfe Peterson, and chairman of the Board of Hewlett-Packard corporation, David Packard.
- May - R. I. convention was held in Mexico City (16th-20th), and the District Assembly was held in Vallejo on the 25th.



June - Sponsored by Fortuna a new Rotary Club was chartered June 8th at Ferndale.

Sandwiched in between the events in the calendar above were a club bulletin improvement contest, won by West Santa Rosa, discussion of redistricting California, formation of ROTARY VOLUNTEERS ABROAD (a program of R. I. president Luther Hodges in which project descriptions were furnished by each club), and ROTORACT CLUBS (service clubs for youth 17 to 25 under sponsorship of any Rotary club in the district. Young women as well as men may become members in these ROTORACT clubs if sponsoring club approves).

When President Hodges said "Let's make our Rotary memberships more effective--it's up to us to get all of our members more personally involved" little did he dream that one of his most effective lieutenants would be Jack B. Power, district governor of #513 during 1967-'68.

## ROBERT E. BARWICK

1968 – 1969

The first governor-nominee ever from the 127-member Napa club, founded in 1922, was Robert E. Barwick. Born in San Francisco, August 28, 1920, Bob has lived in Napa since 1936. He and his wife, Florence, have three children. At the time of his incumbency he had one of his children each in grade school, high school, and college.

A former Napa baseball player and manager, Bob also likes golf and swimming. A 1943 graduate of the U. S. Merchant Marine Academy he held a chief officer's license on Matson freighters during WWII serving until 1946. With his father he owns Dutton's Napa Stationery and Barwick's Business Machines, Inc. His Rotary classification is senior active (formerly Business Machines).



Bob was active in many phases of community betterment. He served on half a dozen philanthropic fund drives. He was a member of several civic and fraternal organizations. He has been a Grand Jury secretary and Chamber of Commerce Director.

To say that district activities followed a traditional pattern during his term would not be correct. Bob reported once: "I am amazed at the different ways of promoting projects with the same avenue of service".

The masthead, "BOB'S BOOSTERS" on the district governor's newsletter indicated the degree of cooperation expected by the governor from every club member and president. He himself set an example of industry and hard work. By August 31st, when everyone else might be thinking of vacation, he had visited 38 of the district's 61 clubs.

He set as one of his goals for the year improving the efficiency of the individual Rotarian. He stressed attendance. Records show his own club under his leadership, for the first time since 1947, had one month of 100% attendance. Bob himself at this time had a ten year perfect attendance record.

Throughout the year R. I. president Kiyoshi ("George") Togasaki's theme "PARTICIPATION" was used and developed. At the end of the year, for instance, Bob could report that "all clubs are now 100% Rotary Foundation contributors".

District functions held during the year included a Leadership Forum at Cabrillo College, Santa Cruz, on October 26th. Dr. Eugene E. Dawson, PDG of #545 and college president from Denver, Colorado, was moderator. He was to return later to moderate the district assembly held at College of Marin, Kentfield, on June 7th.

Interact Week was held January 12th-18th. The annual Interact Conference for the district was held at Fortuna on March 21st with 300 students in attendance. The district conference was held in Napa, April 17-19, with every club (62) in attendance. The R. I. convention, held in Honolulu, May 25-30, placed limitations on how many could attend.

Two new clubs came into being during the year. Southwest Eureka received its charter on March 22nd while Almaden Valley (San Jose) held its charter night on April 26th. During the year San Francisco, Rotary's Club #2, celebrated its 60th year. District membership strength during the year went above the 4,900 mark.

## HAROLD K. GRAVES

1969 – 1970

“ROTARY IS BIG BUSINESS AND ITS BUSINESS IS SERVICE!” So stressed District Governor Harold K. Graves early in his leadership of District #513’s sixty-three Rotary clubs.

President of Golden Gate Baptist Theological Seminary in Mill Valley, Harold came to California in 1952 from long pastorates in Oklahoma. Becoming a Rotarian in 1959 he was elected president of the Mill Valley club for 1964-’65. He and his wife, Frieda, have two married children and three grandchildren. “We never knew what Rotary was until we visited the clubs of #513”, remarked Harold in August of his year of incumbency.



He headed his monthly newsletters: “EnGRAVEings From Harold”. His probably was a school-teacher’s approach to his duties. He covered all bases, however, and kept a gentle pressure on club presidents. He expected them to do the same on their committee chairmen and members. The results in all phases of Rotary’s multi-faceted program at the end of his term clearly vindicated this approach. R. I. President Conway’s theme for ’69-’70, “REVIEW AND RENEW” was ably carried out in District #513.

During the year two new clubs came into being. Westgate, meeting in San Jose and sponsored by the Campbell club, received its charter June 10th. East Santa Rosa, sponsored by the Santa Rosa club, received its charter June 13th. With its 65 clubs and over 5000 members, District #513 was the largest in the Rotary world.

While administering the larger district new levels of progress were achieved under Governor Harold’s leadership. The entire district advanced 100% in Rotary Foundation participation. A new Rotoract club was formed at Menlo Park, the second one in the district (the first one had been a joint venture of two clubs, Sunnyvale and Cupertino). A youth activities week had been observed for the first time, October 5-11, VISA ‘INTERACT and other programs were stressed. A group study team from England was hosted in the fall.

The district conference, April 23-25, held in the Fairmont Hotel, San Francisco and hosted by the Mill Valley club, had as featured banquet speaker Lt. Gov. Ed Reineke. R. I. president Conway’s personal representative was R. I. director Francisco Delgado of Manila. The Bru Brunnier award for international service went to the South San Francisco club which hosted twenty Rotoract youths from Milan, Italy, for a week in March. The Eureka club received a significant achievement award while the Bayshore Club was granted honorable mention.

The June 13th District Assembly at Cupertino was a success with all clubs represented. Attendance was 241.

During the year, Napa observed its 50th Rotary year. The per capita tax for district support was raised to \$5.00 per member.

When R. I. convened in Atlanta, May 31-June 4th, DG Harold could hand the gavel of leadership over to his successor with the confidence of a splendid year filled with a high level of accomplishment.

A major project during this year was the re-districting of #513. Effective July 1, 1970, a new District #517 was created from a portion of District #516 and those #513 clubs of Santa Cruz, Santa Clara and San Benito Counties (Vallejo was transferred to District #516 and the Bayshore club elected to transfer to #517 with Palo Alto). In all 23 of our clubs were transferred to a new district, leaving District #513 with 42 clubs and 3239 members in Del Norte, Humboldt, Mendocino, Lake, Napa, Sonoma, Marin, San Francisco and San Mateo Counties.



## REIDAR H. (RAY) WINTHER

1970 – 1971

Norwegian-born Reidar H. (Ray) Winther came to the United States in 1921 at the age of twelve. A graduate of Stanford "U" he was for twenty-five years the owner of the Ray Winther Company. Selling the business in 1966 his present interests include Lake Shasta Caverns near Redding, California. With his wife, Mabel, he lives in San Carlos but is a long time member and past president of the South San Francisco Rotary Club. He has had much experience in community and church life all of which fitted him in a fine way to serve the forty-two clubs and 3,253 members of District #513 as district governor in 1970-'71.

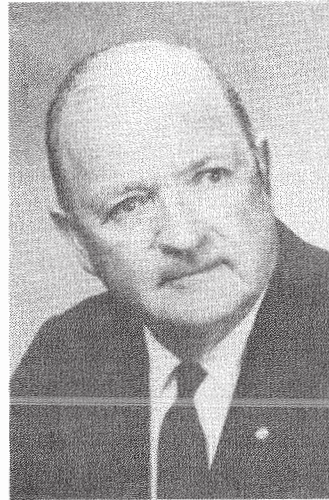

From the start of his term of office, he called on clubs to let go of old established projects and to tackle a new need or project. Capitalizing on R.I. President Bill Walk's theme, "BRIDGING THE GAP" he emphasized bridge-building. This was accomplished through World Community Service, Exchange Study Groups, Rotoract, Rotary Foundation and other activities. An amazing list of accomplishments during the year within the district and by individual clubs would have to include the following:

1. Approval of a Group Study Exchange with #513 by District #132 of Sweden.
2. A "Friendship Center and Tool Library" for lending of farm implements established with Chunchon, Korea Rotarians, by the Lakeport club.
3. The setting of a goal of \$6,700 within the district for a matching fund—dollar for dollar— with Rotarians of Jodhpur, India, in a joint school building effort there.
4. At a cost of just under \$2,000 the nine clubs of Sonoma County provided and presented a small Renault panel truck to the Dagoretti Children's Center in Nairobi, Kenya (District #220).
5. One hundred technical textbooks, valued at over \$800, were contributed by the San Francisco club to the Minas Institute of Technology in Governador Valadares, Minas Geraise, Brazil.
6. The collection of surplus medical supplies by the Redwood City club for shipment overseas.
7. A Wewak, New Guinea, book project.
8. The circulation of POW release petitions which drew 1554 signatures. Also, shipment of the Vietnam Santa Claus pacs which drew the grateful response of servicemen, troop commanders and chaplains.

Partial stimulus for the above accomplishments no doubt came from President Walk's setting aside the meetings during the week of March 28-April 3rd as World Community Service Day.

By reason of #513's record breaking contribution of \$19,608 to the Rotary Foundation in the year '69-'70, an extra Foundation award was made to #513. District #513 has contributed \$196,033 to date.

R. I.'s 66th birthday anniversary was observed on February 23rd. District #513's Interact conference was held at Santa Rosa. Attended by eighty-eight members and about fifteen advisors the conference elected as Interact governor Miss Jody Hansen of Eureka.

The district conference was held in Burlingame, April 22-24, with John V. (Vince) Lemmon, PDG of #519, Sacramento as President Walk's personal representative. The district assembly was held in Santa Rosa on June 5th.

A wide traveler, Ray and his wife, Mabel, attended the ENEAM Rotary Regional Conference in Rome, Italy, November 12-15, 1970 and the R. I. convention in Sydney, Australia, May 16-20, 1971.

A new club was established at Half-Moon Bay. Its charter night was June 18th. It meets at the Moss Beach Rehabilitation Center.

Finally, four members in the district reported perfect attendance for over 2,000 meetings. This adds up to about forty-two years perfect attendance each! The Guerneville club established a record of eighteen months 100% perfect attendance. Truly, it was a banner year in the district for Ray in '70-'71.

## CHARLES M. (CHARLIE) STROPE

1971 – 1972

Charlie was born in Idaho, but moved to California at a young age and graduated from the University of California after an intervening period of service with the Army Air Force in Italy during World War II. He has been owner-manager of the Times Printing Company in Eureka for 20 years. He served as President of the Rotary Club of Eureka in 1968-69 and Area Representative during the following year. He was president of Baywood Golf and Country Club, is a member of the Eureka City Planning Commission and has been involved in numerous civic activities in Eureka. Charlie and Gladie have four children – two married sons and two daughters.



Rotary International's President Ernst Breitholtz's theme for 1971-72 was "Goodwill Begins With You" and Charlie attempted to radiate this concept into all 43 clubs of District #513.

In light of an actual loss in membership in many parts of the country, considerable effort was made to promote membership growth and the year ended with a net gain to 3297, no club having less than 25 members. District attendance during the year averaged well over 90% with the Guerneville club accounting for a series of 100% months.

By resolution an International Transient Visitors Committee was established whereby Rotarians of the clubs within San Francisco, San Mateo and Marin Counties could cooperate to properly and efficiently entertain the great number of Rotary sponsored international visitors who visit the Bay Area each year. Two other district resolutions were adopted and the revised resolutions were reprinted.

A comprehensive District Statistical Survey was completed which provided district clubs with many details of club finances and operation which they might review and compare with their own. District #513 clubs contributed almost \$19,000 toward the Rotary Foundation.

The district history was brought up-to-date and plans made to add this information to existing copies of "The Golden Book of Rotary – 513". A recommended new member indoctrination form was also provided for club use.

The District #513 Interact Club held a workshop session in Ukiah November 13 and then a very successful District Conference in Eureka on March 17 and 18 led by District Governor Jody Hansen, of Eureka.

Rotary Anns were very active in World Community Service as Gladie Strope promoted projects for the ladies within each club as they were visited. This resulted in several very substantial programs and international contacts with many parts of the world.

Two Rotary Foundation Fellows were selected, Jim Hoff of Eureka going to France and Linda Loomis of Arcata to Germany. Meanwhile several Rotary Fellows from other countries were studying in District 513. The committee selected the three nominees for which the district was eligible for the academic year 1973-74. The year saw four new Paul Harris Fellows in District #513: Carlos Freitas and Haddon Salt of San Rafael and George Baker and Charlie Strope of Eureka.

Five fine young men and their Rotarian counselor from Sweden spent portions of January, February and March visiting the length of District #513 as part of the Group Study Exchange program of the Rotary Foundation. Our group will return the visit in May, 1973.

"Mr. Rotary", Bru Brunnier, passed away at the age of 89 after serving as president of the San Francisco club in 1913-14, District Governor in 1915-16 and President of R. I. in 1952-53. He had only recently been recognized as the oldest living Rotarian in point of service in the world. By his will, a substantial portion of his estate was to be left to the Rotary Foundation.

District #513 contributed \$5,000 toward completion of the school project in Jodhpur India. This money is being matched by Rotarians in that District and the school will be dedicated next year.

Governor Charlie served as the district's Legislative Representative during Rotary's first separate legislative session held prior to the International Convention in Houston. A two day session, it covered a wide variety of proposed enactments and resolutions, the most significant of which probably was that which made Senior Active Status mandatory to any Rotarian who qualifies in any manner.

Two District 513 clubs celebrated Golden Anniversaries: Santa Rosa and San Rafael.

An outstanding project was that of the Rotary Club of South San Francisco who dedicated a one hundred and eighty-three apartment "Rotary Plaza" for senior Citizens of that community. The effort headed by Rotarian Bill Meehan, required a great deal of contributed services and particular effort in the area of accounting for financing through assistance of the local carpenter's union and the federal government. While filling a genuine need in that area, it represents what must be one of the most ambitious projects of Rotary history.

A high point of the year was the District Conference in Eureka May 10 - 14 which saw a great number of Rotarians and Rotary Anns enjoying the many unique features of this "Conference in the Redwoods" as 100% of the district clubs were represented. The special hospitality of the smaller, more isolated city, as contrasted with the larger cities in which most conferences had been held obviously appealed to visitors from the southern end of the district. J.P. Duminy, of South Africa and a past vice-president of Rotary International served as R.I. President's Representative.

A highly productive District Assembly, with 249 in attendance, was held in San Rafael on June 24, 1972.

District #513 was a strong and healthy organization at the end of this year with considerable attention having been given by Governor Charlie to basic organizational needs of the district and some of its smaller clubs.



## ALFRED D. (AL) QUILICI

1972 - 73

"Let's take a new look!" was Rotary International president Roy D. Hickman's theme for 1972-73. As the year progressed, he added the words "and Act."

During the year many significant accomplishments were recorded. Among them was the promotion of new and current Interact clubs. The Interact convention was held at Holiday Inn in Terra Linda. In the fall of '72, the Eureka and Terra Linda clubs hosted eight Interactors from Japan. Outgoing Interact governor, Lisa Bollen, was selected in June to attend the Third International Young Adult Leadership Conference at the University of Colorado at Boulder.



After a Group Study Exchange team, consisting of five young men, ages twenty-five through thirty-five, plus Swen Gummer, Cloverdale, a Swedish-speaking leader was found, a successful experience was carried out in Sweden in May. The host country provided travel and lodging while the team was in that country. Gary Goss, San Carlos, chaired the program in the district. Next year #513 anticipates an exchange with District #486 in Argentina.

Another high-light of the year was the record \$71,781.07 (as of May 31st) contributed by clubs in the district to Rotary Foundation. This is the district's largest ever contribution and was substantially the result of a \$50,000 bequest in the will of Bru Brunnier.

A huge delegation attended the International Convention held in Lausanne, Switzerland, May 13th to 17th.

New clubs were established during the year at Clearlake (sponsored by the Lakeport club), and at Corte Madera (the Central Marin club sponsored by Mill Valley). The District now totaled 45 clubs with 3427 members.

The district conference and the district assembly were of the usual high calibre this year. The former was held in San Rafael, April 16th-18th. Its men's luncheon had as speaker Mr. Charles L. Gould, publisher of the San Francisco Examiner. The district assembly was held at Sonoma State College, Rohnert Park, and was addressed by General Maxwell B. Taylor.

A glowing report of District #513's school project in Jodhpur, India, was given by PDG Ray Winther. Accompanied by Mrs. Winther, Ray participated in the dedication. He stated that India's district #305 more than matched the \$11,700 (80,000 rupees) donated by our district.

Other past district governors in the limelight during the year were Norman DeLaittre, named our most recent Paul Harris Fellow (the district now has eleven); and Wally Myers who was named R.I. president Roy Hickman's personal representative to Oregon's district #511.

We mourned the passing of two former district governors: Herb Walton, who served in 1934-'35, and Joseph Gabriel, governor in 1945-'46.

John Dalton was our RI representative at the district conference this year. Looking ahead, John Withers of the Santa Rosa Club was named governor of the district for 1973-'74.

The generosity of the local clubs within the district was attested to by the response given to an appeal from Ilan, Taiwan, for books for a children's library; for an ambulance, stretchers and X-ray for East Launda in Angola (Portuguese West Africa), and for medical books for a new school of medicine in Barbacena, Brazil.

On June 30, Governor Al participated in a pleasant ceremony when he assisted members of the Rotary Club of Petaluma as they presented a Paul Harris Fellow award to Homer Wood, founder of the Rotary Clubs of San Francisco and Petaluma. Homer, age 93, resides in Porterville and was the first president of both these clubs.

Each individual Rotarian and every club within the district can be proud of the leadership of our district governor, Al Quilici. He in turn, we know, is justly proud of every cooperating club and each individual loyal Rotarian in the district all of whom made possible an outstanding year of achievement.

## JOHN K. WITHERS

1973— 1974

John K. Withers was born in Rochester, Minnesota. In 1948, he graduated from the United States Military Academy, West Point, NY, with a BS Degree in Engineering. He was a Strategic Air Command Pilot and Atomic Bomb Commander, flew 33 missions in Korea and later served as a multi-engine instructor pilot. In 1955, he resigned his commission and entered Syracuse University and was awarded an MS Degree in business. After a six year career in Radio-television time sales, he became a real estate investment broker in Santa Rosa, California. He served as President of the Rotary Club of West Santa Rosa in 1968-69 and as District Governor's Representative in 1971-72. John and wife, Pat, daughter Ginger, and son Skip reside at 220 Country Club Drive, Santa Rosa, California 95401.



The gas shortage after the Arab-Israeli conflict created a substantial problem. Governor John had to ask each Club to furnish him with a tank of gas in order to make the visits.

On May 15-18, the first Conference outside the District was held at Incline Village, Lake Tahoe. It was a great success because of 1) outstanding planning and staff work by Bill Fisher and Carson Mitchell of West Santa Rosa 2) the inspiration generated by the presence of RI Director Ike Parrish and 3) a stirring address given by former Congressman and Medical Missionary to China, Dr. Walter Judd. Undaunted by a blizzard, the delegates and wives enjoyed an outdoor BBQ in a pioneer atmosphere at nearby Ponderosa Ranch, during which they debunked John at a Court Martial headed by John's former Adjutant General, Col Bob Nourse of San Rafael Rotary. The plenary sessions were probably the best attended in recent years, with an average of 90% of all registered Rotarians in attendance and contributing to the discussion.

Under the tremendous leadership of Chairman Mario Nardi of San Bruno, the District hosted five young men and their Rotarian leader from Argentina on a Group Study Exchange. The results could not have been better as they visited clubs throughout the district.

In June, 1974, a great Assembly was held at San Mateo. Each Club in the District was represented, again featuring early starting and early finishing times. The number of Group sessions was increased by adding separate sessions for Bulletin Editors, Public Relations, and Rotary Foundation.

On December 11th, the new Rotary Club of South Ukiah was Chartered, as PDG Harold Graves gave an inspiring address. The upcoming Petaluma Valley Rotary Club was formulated and will be chartered next year.

The number of Paul Harris Fellows in the District drastically increased, with especially great effort from Novato and San Rafael.

John was not afraid to challenge entrenched habits and traditions, and showed that there was a lot of room for improvement and innovation. He especially felt a great need for better continuity in the Office of the District Governor. He convened an Ad Hoc Long Range Planning Committee to study the problems. The immediate result was the decision to have all Past District Governors meet each 90 days with the Governor and Nominee to give the present and upcoming leaders an opportunity to acquire better background information from the reservoir of knowledge possessed by the Past District Governors and to give these new leaders a better perspective on current problems.

Several local Clubs completed significant projects. Sebastopol in one year raised \$49,000 for the local High School athletic field and San Carlos presenting a 57 pound prying rig (Jaws of Death) to the Police and Fire Departments for use in accidents for life saving.

A large delegation attended the International Convention in Minneapolis on June 9-13th. Of the 375 District Governors in Rotary, John was one of 28 chosen to be a Seminar Leader. Charlie Strope, PDG, of Eureka, ably represented 513 at the Council on Legislation.

The 1973-74 theme of RI President Bill Carter, "This is the Time for Action," was well fulfilled in 513 this year under the leadership of District Governor John Withers.



## ROBERT C. GLIDDEN

1974 — 1975

Robert C. "Bob" Glidden was born in San Francisco in 1920. After graduation from local schools, he joined the Homelite Corporation engaged in the promotion and sales of construction equipment in California, Nevada, Hawaii and French Polynesia. World War II interrupted his career and he served in the U.S. Coast Guard in the Hawaiian area. Following the War, he returned to Homelite and retired in 1970. This gave Bob more time to devote to a myriad of outside activities. A list would include Rotary, antique autos, trail bikes, back packing, snowmobiling, a mountain cabin, international friends, Sharon Heights Golf Club and Navy League.

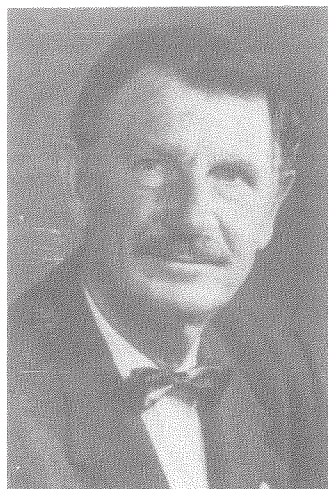

He and his lovely wife, Wanda, have five children and make their home in Hillsborough.

Bob joined the Rotary Club of South San Francisco in May 1956. He served his club as a director and as President in 1966-67. He served as District Governor's Representative and was Chairman of the 1971 District Conference. He was a director and then President of "Rotary Plaza", the outstanding senior citizen's housing complex sponsored by his Rotary Club. Bob became a Paul Harris Fellow in 1973.

International President, Bill Robbins, established "Renew the Spirit" as the theme of his term and D.G. Bob seized that as his motto and went right to work renewing the Spirit of District 513.

D.G. Ken Joslyn of Kenya, appealed for old eye glass frames and Bob challenged the District to respond—resulting in more than 7000 frames being sent and still more coming.

October 23, 1974 was the date to have the Charter Night for the newest club (the 47th) in 513—welcoming the Rotary Club of Petaluma Valley. The Club officially came into existence on August 16.

District 513 is an enthusiastic supporter of the Rotary Foundation. Donations reached \$9.00 per capita in 1973-74 as Bob urged each club to strive for \$20.00 in 1974-75.

Negotiations began for Rotary Group Study Exchange with Vienna, Austria for 1976-77.

\$1,111.00 was collected for disaster relief and sent to Korea, Cyprus, Honduras, India and Bangladesh.

D.G. Bob initiated a District First with the establishment of two "Supermus Rotarian Finitus Awards" which were Paul Harris Fellow Awards to two 513 Rotarians—one North and one South. The outstanding recipients were:

Northern Area—John Kielsing, Guernville

Southern Area—P.D.G. Wally Myers, Ross Valley

A new program of assimilation of new members that sets forth 12 steps over the first 20 weeks was developed. It was a greatly needed and long awaited idea.

On February 18, 1975, a plaque was placed on the Market St. side of the Sheraton Palace Hotel memorializing "Bru" Brunnier and commemorating the 70th Anniversary of Rotary. That corner (southwest corner of Market and New Montgomery) will be known for all time as the "Four Way Corner" thanks to the Rotary Club of San Francisco President Chet McPhee and the Board of Supervisors of San Francisco.

Oscar Lopez of the Rotary Club of San Mateo led a group of five young executives on a group study exchange in Argentina.

April 25, 1975 was the date of the Charter Night for this year's second new club in the District. North Napa was established by the second oldest club in our district, the Rotary Club of Napa, established in 1920. Now District 513 has 48 clubs.

Past R.I. President "George" Togasaki and Dorothy were personal representatives of President Bill Robbins at the 1974-75 District Conference at the Del Monte Hyatt House. 450 Rotarians and their ladies took part in a fine conference.



The Rotary Club of Novato held a ground breaking ceremony for their \$350,000 Senior Citizens Housing Project, totally privately financed with a great deal of the work done by the members themselves. This is a true example of the Rotary Spirit—find a need and fill it.

Paul Harris Fellows in District 513 totalled 70. An increase of 145% in one Rotary year.

Membership had the greatest growth of all California districts—162 to a total of 3648.

Five clubs celebrated their first fifty years during the 1974-75 Rotary year:

Burlingame, founded January 2, 1925

Ross Valley (San Anselmo), founded April 27, 1925.

Ukiah, founded April 29, 1925

Lakeport, founded May 6, 1925

Sebastopol, founded May 26, 1925

It was a fine “Renew the Spirit” year.

## WILLIAM A. JAMIESON

1975 – 1976

Bill Jamieson was born in Alameda and raised in Willits where he attended school eventually graduating from the University of California. He immediately joined the State Division of Forestry where, after serving in many parts of California, he retired in December 1972 after 37 years of service. His forestry career was interrupted during World War II for four years in the U.S. Army where he rose from enlisted man to an officer and served in the Pacific Theatre.

He married Elinor Buck in 1949 and they have one son. He joined the Rotary Club of Fortuna in 1965, served as its president in 1971-72 and as Area Representative in 1972-73. Following his retirement with the Division of Forestry, Bill became the Secretary-Manager of the Redwood Region Logging Conference.



The Rotary year was off to a good start with 48 clubs and nearly 3,600 members. It was the year in which all Rotarians were urged to adopt President Imbassahy's theme "To Dignify the Human Being" and to act and live that motto. By the year's end, the number of clubs had increased to 50 with 3,640 members. The Rotary Club of Novato sponsored and successfully established the 49th club in the district in a period of only four months of the new Rotary year. The new Rotary Club of Ignacio, just an idea in November, received its charter on April 12 and was officially welcomed into the family of Rotary at its Charter night on May 22.

Our 50th club was sponsored by the Rotary Club of Arcata and was the culmination of several years study and work before receiving its charter on April 29, 1976. The club adopted the name of the Rotary Club of Mad River (McKinleyville) and had its Charter night on June 25. Other areas were looked into during the year for future clubs.

One of the highlights of the year was the completion of the Nova-Ro Housing project of the Rotary Club of Novato. This project took about 2½ years from its inception as an idea of Community Service to its dedication and completion on December 12, 1975. The District "Significant Achievement Award" as established by R.I. was awarded to the Rotary Club of Novato for this project. Subsequently, Novato was honored nationally by the National Center for Voluntary Action. They were chosen for one of the six awards out of nearly 1000 nominations throughout the United States. President Ford made the presentation to Rube Kaehler and John Novak representing the Rotary Club of Novato. This project is Community Service at its very best and its recognition within Rotary and nationally is certainly ample testimony of its worth.

District 513 continued its fine record of contributions to Rotary Foundation with an end of the year aggregate contributions of more than \$22.00 per member. The number of Paul Harris Fellows almost doubled with 50 more added to the roster and a like increase in Paul Harris Sustaining members. Two clubs, Sausalito and South San Francisco, went to a high of 3600% in Rotary Foundation with many other clubs showing substantial increases. As a result of the increase in donations to the Foundation, the District was awarded five scholarships and a Teacher of the Handicapped for the 1977-78 Scholastic year. These were picked from a group of 35 candidates from 19 clubs in the District.

This was our year to entertain a Group Study Exchange team from District 181 in Austria. A fine group of five young men with their counselor toured the District and were welcomed in all parts of the District. Their trip ended at the District Conference in Eureka. Preparations were made to return a like group to Austria in 1977.

The disastrous earthquake in Guatemala gave the incentive for a District-wide International project. With a goal of \$1.00 per member per club, the District over subscribed and over \$1.30 per member was raised for a total of \$4,822.00 which was sent to the Emergency Committee of the Rotary Clubs of Guatemala. The project for this committee was to assist in the reconstruction of the town of San Pedro Sacatepequez, a small town northwest of Guatemala City, that was totally destroyed in the earthquake. It was worthy to note that all clubs participated in this endeavor.

During the year, R.I. reinstated the Rotary Information Institute. This was held in District 513 in October 1975 at the Golden Gate Baptist Theological Seminary with PDG Bill Huggins of District 511 as the representative from R.I. Subjects covered this year were Rotary information, membership development, public relations and youth service committees.

The District noted the loss of two PDG's in 1976, namely Norman C. DeLaitre (1961-62), Rotary Club of Cloverdale and Monroe F. (Brownie) Brown (1957-58), Rotary Club of Burlingame.

Four clubs celebrated their 50th year of Rotary in 1976. Proper celebrations marked these Golden Anniversaries. Those clubs who reached this peak in Rotary were:

Rotary Club of Arcata, February 8

Rotary Club of St. Helena, March 8

Rotary Club of Cloverdale, June 2

Rotary Club of Mill Valley, June 7

This made a total of 8 clubs in two years that attained the 50 years of Rotary. It brought to a total of 17 or 34% clubs in the District who can claim this distinction. In addition, two clubs celebrated 25 years of Rotary during the year. Both the Rotary Club of Ft. Bragg and South San Francisco celebrated this mile-stone of Rotary.

The District Conference was held in Eureka on May 6--8. The President's Representative was Keith Burnham, R.I. Director.

The International Convention was held in New Orleans on June 13--17.

With the International Convention to be held in San Francisco in 1977, all clubs contributed to a fund to offset the cost of hosting the Convention. Plans were begun by the Rotary Club of San Francisco, aided by other clubs in the District as well as the other Districts in Northern California.

Group of Rotarians from Taiwan toured the District in May of 1976 and were greeted by several clubs.

The Interact Convention was held in May at the Pacifica High School under the leadership of Marie Manio, Interact Representative. Although there was little growth in Interact during the year, a sound basis for the growth was established.



GEORGE P. NEWLON

1976 – 1977

George P. Newlon sold a great deal of Campbell Soup during a 42 year career which saw him retire as Northern California District Sales Manager in 1976 and he continued to exercise that same energy, enthusiasm and personal sales ability during an extremely productive year of Rotary in District 513. Rotary International President Bob Manchester chose "I Believe in Rotary" as his theme for the year 1976-77 and George left little doubt that indeed he totally believed in his product.



George was born in Missouri in 1910 and graduated from Colorado State. An active member of the San Mateo club, he served that club as Director and then President in 1967-68. The following year, he was the District Governor's Area Representative and in 1970-71, was Special Representative for the formation of the Half Moon Bay Club. He was District Extension Chairman in 1974-75 and worked on the chartering of the Petaluma Valley and North Napa Clubs and was in charge of Rotary Foundation Promotion in 1975-76.

George always had an interest in track and served this sport in many capacities, both locally and with Olympic Committee activities serving for many years as Commissioner of Officials for the AAU and Stanford University.

George also served five years as County Chairman for the March of Dimes, served on the Board of CHAD, Planned Parenthood, S.A.R., and was a member of the 1977-78 Grand Jury in San Mateo County. He was named "Bay Area Citizen of the Day" for his work with youth and retarded children in the Special Olympics, being similarly recognized by B'nai Brith. He was also named "Outstanding Official" in 1975 by the University of California, Berkeley.

Probably the major accomplishments during George's year were in the area of Rotary Extension and the Rotary Foundation. For the first time since 1948, there were as many as three new clubs chartered in District 513. They were Foster City, Rohnert Park-Cotati and Tiburon-Belvedere. This effort resulted in a gain in membership of District 513 from 3646 to 3802 in a total of 53 clubs. This large number of clubs gave George cause to suggest that it was time to consider a redistricting effort, particularly in view of the fact that it takes a number of years to accomplish such a move after it has first been recommended. (The last time such a change was made was in 1970 when District 513 had 65 clubs with over 5000 members.) This subject was discussed on the program of the District Conference.

George used each visit to a club to promote the Rotary Foundation. The result of this effort and the work of his Foundation Committee members was a new record contribution of over \$93,000 with over 80 new Paul Harris Fellows for the year and a new record per capita contribution from the district of \$22.54. Once again, District 513 was eligible for four additional Foundation program awardees, for a total of five.

No small part of the success of George's Rotary Foundation program was the effort of his Rotaryann, Claire, who published a cookbook made up of recipes from Rotary Anns in the district. The net proceeds of the sale of 2,000 cookbooks resulted in about \$3,000 profit which was contributed to the Foundation. Specifically, it was delivered in the form of 3 Paul Harris Fellow awards – PDG Bob Barwick, PDG Harold Bostock and Claire Newlon.

A featured column in George's fine monthly newsletter entitled "George's Grumblings" was consistently entertaining and inspirational.

A Group Study Exchange with District 181 of Austria saw John Kiesling of Guerneville lead five young business and professional men on a trip to that country.

A very successful District Rotary Institute was held at Golden Gate Baptist Theological Seminary in December. It was attended by 160 from 52 clubs including Foster City and Rohnert Park-Cotati not yet chartered! PDG Larry Lyles of Visalia was R.I. Counselor at the Institute.

John Novak and Rube Kaehler were honored at Washington D.C. by President Ford in recognition of the Novato club's "Nova-Ro" housing project. This project was one of six such community efforts selected from over 1000 nominated (A few months later, was to see an overflow attendance at the funeral of John Novak, always to be remembered as a great Rotarian of this district.)

Homer Wood, founder of the Rotary Club of San Francisco and a major factor in the growth of Rotary in the west, passed away.

A project to collect old eyeglasses resulted in a shipment of over 10,000 pairs to South American countries.

For the first time in many years, the District Conference returned to Clear Lake where, at Konocti, a gathering was held that pleased everybody. Speakers included R.I. President's Representative Bud Coulsen and former R.I. First Vice President, Stan McCaffrey.

George and District 513 acted as host to the Rotary International Convention at San Francisco and it had to be considered among the best ever. Certainly a major contribution to the success of the convention was a tremendous job performed by Chairman Ray Winther and his Home Hospitality Committee as they arranged for the entertainment of over 6,302 visiting Rotarians and their families at 2,540 homes around the Bay Area as far away as Cloverdale, Sacramento and Watsonville, with 109 clubs participating. Transportation was provided by 113 buses, more than 1000 automobiles, four ferry boats, BART and Taxis. PDG Al Quilici was Chief Sergeant at Arms of the Convention.

The Council on Legislation met before the Convention and a matter of considerable interest to all was the very controversial issue of whether or not women should be eligible for membership in Rotary. At least until the next council, it was voted down after considerable debate. Charlie Strobe ably represented District 513 on the Council.

George had every reason to be proud of the year he served as District Governor for it was a year of many outstanding accomplishments.

## ARTHUR W. AGNEW

1977 – 1978

Art, before he became Senior Active, was the holder of the unusual classification of Fishing Line Manufacturing. He is the first governor from the Rotary Club of Petaluma, and served under International President W. Jack Davis of the Rotary Club of Hamilton, Bermuda. Davis's theme was "Serve to Unite Mankind", while Art's was "Attend and Participate". It was a year of innovative change as Art critically examined many customs and policies of the District. Based on consideration of improving the operations, many changes were put into effect throughout his term.



A Rotarian since April of 1951, Art has maintained a perfect attendance record for the past 26 years. He was elected president of the Rotary Club of Petaluma to serve for the year 1966-67, and as Area 4 Representative for Governor Bill Jamieson in 1975-76. A native of San Francisco, he was raised in Alameda, attended the University of San Francisco on a baseball scholarship, and received his B.S. in accounting in 1935. Soon after, he became associated with the Sunset Line & Twine Co., and for the past 15 years has served as its president. He and his wife, Evelyn, have two sons and a daughter. Art, Jr., a charter member of the Rotary Club of Petaluma Valley, served as its third president.

One of the few governors who could use his full name in the newsletter, his own was known as "Agnewsletter" and contained a balance of news, messages and Rotary information. It also included numerous departments, one being the international officers; another, past district governors; and a third, area representatives. He included a financial statement in one issue.

During the year, the Rotary Club of Tiburon/Belvedere held its charter night on July 27, 1977, with Past First Vice President of Rotary International and Past Governor of District 513, Dr. Stan McCaffrey, as the keynote speaker.

District 513 was again matched with Pakistan District 327 and efforts were made to develop an international service project by obtaining medical books.

The District felt the loss of two of its most dedicated members: John Novak of the Rotary Club of Novato and Henry Spiegel, long time secretary of the Rotary Club of Napa. According to an R.I. news publication, PDG Harold M. Graves of the Rotary Club of Mill Valley had died during the year, but the erroneous story proved to be referring to a Harold M. Graves of New York.

A very fine District Institute was conducted at the Golden Gate Baptist Seminary on December 3rd, under the leadership of Bill Huggins, PDG of District 511. The entire expense was born by the District.

R.I. headquarters suggested an indoctrination program for incoming presidents, so Art and DGN Bob Paroli established meetings in Eureka, Ukiah, Novato and San Bruno for this purpose. Only 3 of the 53 presidents-elect did not participate. Once again, the entire expense of these meetings was handled by the District.

It was announced that the Foundation per capita contributions during the preceding year, under the leadership of George Newlon, reached \$22.54, and District 513 was 36th in the world per capita contribution and 22nd in dollar contribution. During Art's term, Paul Harris Fellows swelled to a total of 275, with over 200 more as sustaining members. The District contributed in excess of \$143,000, which qualified them for 6 awards, plus a candidate for the teacher of the handicapped and journalism.

Under the leadership of PDG Bill Jamieson the Rotary Foundation Awards Committee interviewed 49 candidates and selected 6, plus a candidate for the teacher of the handicapped.

Harry Empey, from the Rotary Club of Santa Rosa, was selected as District Governor Nominee to serve as governor for the year 1979-80.

A Future Projects Committee was created for the purpose of considering District projects, as well as assisting District 513 clubs in developing and implementing their own projects.



March 6th through 10th was designated as 100% Attendance Week. 27 clubs reached that figure and some missed only by 1 or 2 absences. The Rotary Club of San Francisco hit an all time high in attendance for that week with a 89% figure.

The well attended District Conference was held in Santa Rosa April 18th through the 20th. The program included some spirited discussions, both in the form of group sessions and resolutions. Dr. William Frank, Past Governor of District 526, was President Davis's representative. A Group Study Exchange team from District 207 in Italy participated, which was the culmination of their 6 weeks visit in our District.

PDG Al Quilici brought honor to the District by acting as the President's Representative to District 526 at their conference in San Diego. Other honors bestowed on PDGs were at the Zone Institute in Las Vegas in January, 1978; PDG Al Quilici was the Chairman of the Sergeant at Arms Committee, PDG Bob Glidden was Chairman of the Visiting Dignitaries Committee and PDG Charlie Strobe was a speaker at one of the sessions. There were 9 participants from District 513.

The International Convention was held in Tokyo, with a record of over 40,000 registrants, with more than 50 from District 513. Art, in addition to participating at the convention, served as host for a Rotary group tour through southern Japan, the Republic of China, Hong Kong and the Philippines. He spoke at the Rotary Club of Fujisawa West in Japan and along with PDG Charlie and Gladys Strobe, he and Evelyn attended a special dinner meeting honoring Jack Davis in Hong Kong.

The District Assembly was held at the beautiful State College campus in Rohnert Park. A fellowship meeting the evening preceding featured wine tasting. Campus housing was made available for registrants who wished to take advantage of it. A total of 11 discussion groups were established and a special ladies day program at the college was warmly received by the Rotaryans. The District handled the costs, except for the luncheon.

It was a year which saw a good many changes and found District 513 on a firm foundation for future years.

## ROBERT J. PAROLI

1978-79

Robert J. (Bob) Paroli was born in 1931 and joined the Rotary Club of Menlo Park in 1959. Active in Masonic and Shrine activities, he has been involved in many other community activities including YMCA, Chamber of Commerce, High School Dad's Club and the PTA. Bob was president of his club in 1974-75; Area Representative for District Governor Bill Jamieson in 1975-76 and was involved in Rotary Club extension efforts. He was a guiding light in the chartering of the Foster City, Tiburon-Belvedere, and Rohnert Park-Cotati clubs. Bob and his Rotary Ann Martha have four children.



Bob's classification is Building Maintenance and he spends what time he can flying his own airplane. By coincidence he was actually making his first solo flight while the District Nominating Committee was trying to reach him to tell him about his selection as District Governor-nominee. Some of his flying friends refer to him as the "Purple Pisano" – Italy's answer to the "Red Baron."

Rotary International President Clem Renouf of Nambour, Queensland, Australia adopted the theme of "Reach Out" and Bob certainly complied as he reached out into every club and avenue of service while he pursued his responsibilities throughout the district. This he did with a rare combination of hard-working diligence, conscientious concern and unique good humor.

President Clem announced and began to promote plans for a 3-H (Health, Hunger and Humanity) program to be implemented over the next two years. This program hopefully would raise \$12 million by 1980 and will be used to improve health, alleviate hunger and enhance human and social development in all peoples of the world. His goal was a club contribution of \$15 per member or \$1500. Redwood City made the first \$1500 contribution and other clubs followed suit. PDG Harold Graves and PDG George Chaffey were named as co-chairmen of the District 513 3-H Committee.

Bob produced an excellent monthly newsletter which imparted news, Rotary information and above all, Rotary enthusiasm to his readers. His regular editorial "Parole de Paroli" ("Words of Paroli") always contained an inspirational message. The Garberville club was included in the newsletter when two of their members were pictured within the Artic Circle indicating alleged plans for Rotary extension there.

It was District 513's turn to send a Group Study Exchange team to District 207 in Italy. Led by Rotarian Mario Nardi of the San Bruno club, they made the trip a total success and made a tremendous impression upon their Italian hosts. The team was made up of young men representing the full length of the district.

A district golf tournament was conducted at Marin Golf and Country Club. The funds raised are to be used to assist clubs with worthwhile projects in the making.

The Novato club announced that another 52 of their members had become Paul Harris Fellows as a result of the sale of the "Dream House" which they had constructed. This was a record for such awards made at one time within a club and the project was featured in the Rotarian Magazine.

Youth Exchange chairman Dave Dillon of Eureka had a busy year developing an active program in District 513. On one occasion Governor Bob and Belmont Rotarian Fred West flew two Australian young people to meet their hosts in Eureka.

Several District 513 Rotarians and their Rotary Anns attended a dinner in Los Angeles honoring President Clem Renouf. President-elect Jim Bomar honored the district with a visit to the Bay Area and a lunch with the Marin County clubs.

For the first time in District 513, incoming 1979-80 presidents of districts clubs attended a training seminar at the Claremont Hotel in Berkeley. For the two-day session, leaders included Past-Directors of R.I.

The district was honored as PDG Al Quilici was selected as a Group Discussion Leader at the International Assembly in Boca Raton. Al also served as the R.I. President's Representative to the District 526 Conference.

April saw Rotary family day at Candlestick Park for a Giants-Dodgers baseball game. A portion of the admission paid by Rotarians was used to make a Paul Harris Fellow of one of those in attendance. The Rotarian whose name was drawn was Robert Schlager of Santa Rosa.

President Clem and Governor Bob began to promote 75th Anniversary club projects for next year.

As a result of outstanding support for the Rotary Foundation it was announced that District 513 was eligible for six awards plus an opportunity to compete for a Journalism and Teacher of the Handicapped award. With a per capita contribution of \$39.82 in 1977-78, District 513 ranked fifth in the world within the Rotary Foundation.

A truly outstanding District Conference was held at Clear Lake's Konocti Harbor Inn. Dr. W. Grattan O'Connell of Auckland, New Zealand was the R. I. President's Representative.

The International Convention was held in Rome, Italy where Governor Bob and PDG Al Quilici were co-chairmen of the California breakfast.

Rube Kaehler of Novato was selected as Governor-nominee for 1980-81. R.I. chose a new General Secretary in Herbert Pigman.

The year's District Assembly was held on a beautiful, sunny day on the campus of Santa Rosa Junior College.



## HARRY C. EMPEY

1979-80

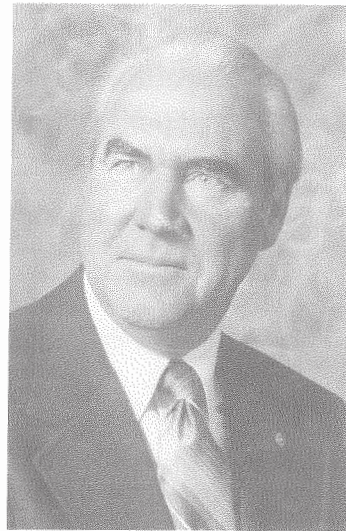

1979-80 was a very special year for Rotary since it was the 75th anniversary of this oldest of service clubs. The occasion was celebrated in various ways throughout the district.

The leader of District 513 during this important year was Harry C. Empey of Santa Rosa and he energetically pursued the motto of R.I. President Jim Bomar "Let Service Light the Way."

Harry was born and raised in Utah. He graduated from the University of Utah School of Business Administration after which he went to N.Y.U. on a scholarship and received a master's degree in retailing. Harry was an outstanding athlete in track and basketball and still is an avid sports fan. During World War II he served in the Navy and saw action in both the European and Pacific theatres all aboard an L.S.T. as Group Supply Officer. After 22 years with the J.C. Penney organization, he purchased two ladies and infants apparel stores which he operated for 13 years. Harry then went into the real estate business. He has been active in many civic organizations. Harry's wife is named Ella and they have five children.

This was the primary year of effort for the 3-H Program – Health, Hunger and Humanity. To commemorate the 75th anniversary of Rotary, clubs throughout the world were encouraged to devise a special program, project or activity. During the year Harry was able to identify many outstanding projects carried out by District 513 clubs in his monthly newsletter.

Clubs were also encouraged to prepare a club history as part of the observance.

1980 was a leap year and Governor Harry asked Rotarians to dedicate themselves to an extra day of service.

It was reported that 1979-80 was a record year for the Rotary Foundation with more than \$16.1 million being contributed. This was a 6% increase over the \$15.2 million of last year with 10,828 Paul Harris Fellows named during the year. District 513 played a great part in this as they contributed a total of \$125,728.98 or \$32.65 per member. The district achieved the 300% plateau.

District Rotarians participated in a special trip to the Rose Bowl on New Year's Day where they enjoyed grandstand seats at the parade, luncheon and reserved seats at the game. Rotary Zones 1 and 7 had joined in raising funds to build a float for the Rose Bowl parade. Its theme was "Love makes the world go 'round" and "75 years of Service above Self."

Dave Dillon of Eureka continued to work hard on the various Youth Exchange projects of the district.

It was great news to everybody that Past District Governor Stanley E. McCaffrey was identified by the nominating committee as their choice for President of R.I. in 1981-82.

PDG Bob Paroli was chosen by R.I. President Jim Bomar to act as his personal representative at the District Conference held in San Antonio, Texas.

A Group Study Exchange team from Pakistan arrived in April, visited all parts of the district and attended the District Conference.

The District Nominating Committee named Ed Phillips of Willits as DGN for 1981 and he was so introduced at the District Conference. However, personal circumstances made it necessary for him to resign and Bob Rockwell of San Francisco was named, being introduced at the District Assembly.

The club president's training session, chaired by PDG Bob Paroli was conducted at the Claremont Hotel. 242 participants from districts 513, 516, 517, 519, and 522 representing 92.4% of the 259 presidents-elect of those five districts. Bob Tellander of Rohnert Park was Program Chairman of the meeting.

A great District Conference was held at Clear Lake's Konocti Harbor Inn. A large turn-out filled the place to its capacity and there was outstanding participation in the programs. Ron and Miriam Deisseroth of Hawaii represented the R.I. president. By resolution the district per-capita contribution was increased from \$6.00 to \$7.50.

Many District 513 Rotarians found their way to Chicago, the original home of Rotary, where an outstanding convention marked the 75th anniversary of Rotary.

Chicago hosted the Council on Legislation with George Newlon as district representative. While the group was a little more liberal in some of its determinations, the highly controversial question "Women in Rotary" was defeated for another three years.

The District Assembly was held at Indian Valley College in Novato.

## REUBEN W. KAEHLER

1980-81

Reuben (Rube) Kaehler brought to the office of District Governor a well established record of Rotary service over many years. He spearheaded the construction of Miwok Park, the Nova-Ro Senior Citizens Housing Project, and was the spark-plug for the committee which raised \$52,000 for the Rotary Foundation.

Rube was born in Sanborn, Minnesota in 1923. In 1942 his family moved to California where Rube married his Rotary Ann Rena, and went overseas in World War II with the Corps of Engineers.

Rube and Rena have three children. His hobbies are golfing, skiing and flying. Besides flying his own plane extensively for recreational and business purposes, he made most of his club visits by air.

He received the coveted "Silver Beaver" award for distinguished service to youth in scouting. Rube was also a driving force in the formation and construction of a Boys' Club facility in Novato.

Rube joined Rotary in 1956, served as President of the Rotary Club of Novato in 1973-74, and as District Governor Art Agnew's Area Representative in 1977-78.

He was elected President of the San Francisco Builder's Association in 1976 and was President of the Associated Building Industry of Northern California in 1978.

With Rube's commitment to community and Rotary service, it was easy for him to adopt the theme "Take Time to Serve" of R.I. President Rolf Klarich of Finland. He began by organizing a fine, well attended District Assembly at Indian Valley Colleges in Novato with 479 Rotarians and 79 Rotary Anns participating.

Governor Rube arranged a wide mailing of his newsletter, "Reuben's Ramblings," to club committees and general membership. His bulletins contained a wide variety of news and Rotary information of interest to all.

In August Rube announced the ground-breaking of the 63 unit apartment Senior Citizens Housing complex being constructed by the Rotary Manor Corporation, a non-profit corporation formed by the Rotary Club of San Rafael. The value of this complex should be in excess of \$3,000,000 including contributions by Rotary Club members in the form of labor, materials and money.

While the spring of 1980 saw a Group Study Exchange visit by five young professional men with their Rotarian leader from District 327 of Pakistan, District 513 sent an equally fine group to visit that country in the spring of 1981. The group was led by Rotarian Greg Dyer of Mill Valley. The group made a tremendous impression upon the District Conference as they reported upon their activities in Pakistan. District Chairman of the Exchange was Surjit Singh of San Anselmo.

Governor Rube stressed the importance of bringing new members into our clubs, and his efforts were rewarded by an increase in district membership from 3,864 to 4,017.

District 513 supported the Rotary International project of entering a float in the 1981 Tournament of Roses Parade. With the theme "Trails of Happiness" it depicted the concern of Rotary for the handicapped.

The final computer printout for 1979-80 indicated a contribution of \$124,739, or \$32.65 per member, from District 513. For 1980-81 it was \$132,089, or \$33.00 per member.

The Interact District Assembly was held at Santa Rosa on November 22. Chairman John Berglund reported an active session of the young people. A number of new Interact Clubs were established during the year, and renewed Interact activity occurred throughout the district.

Chairman Dave Dillon of Eureka promoted an active Youth Exchange program during the year, extending these exchanges to Marin and Sonoma Counties, and other parts of our district.

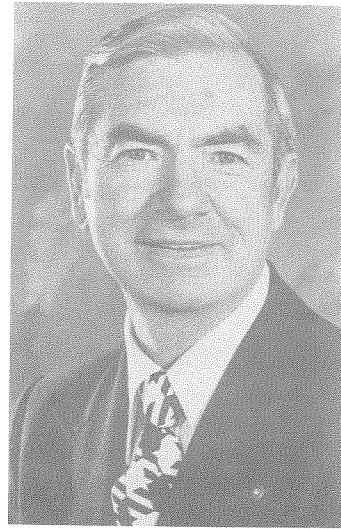



December saw a special event at the St. Francis Hotel in San Francisco as R.I. President Rolf Klarich visited our district. Governor Rube and Rena acted as aides to Rolf and his wife Kathy. San Francisco President Lloyd Pflueger was chairman of the affair as nearly 400 Rotarians and their wives gathered to honor their leader.

Spurred on by Governor Rube, the San Francisco Club achieved a 75% attendance for the month of January – a marked improvement over previous months.

The District Governor Nominating Committee announced that their selection for the year 1982-83 was Dick Keith of West Santa Rosa.

Governor Rube reported that the 3-H (Health, Hunger and Humanity) program is alive and well, with numerous accomplishments in certain less fortunate parts of the world.

He spoke at the 50th Anniversary celebration of the Guerneville Club on June 16.

A new club was worked on in the East San Rafael area. A survey was made, and San Rafael agreed to sponsor a club. Forest Goff of San Rafael was chosen as special representative. The club should receive its charter in a few months.

Throughout the year Rube concentrated a great deal of attention upon his plans for the District Conference. Each individual Rotarian of the district received a “dynamite stick” containing information about the great conference to be held at the Red Lion Inn in Sacramento. Chairman Gordon Lee, assisted by John Stuber, and an enthusiastic group of Novato Rotarians, indeed did put on a fine conference. It was extremely well attended with 734 Rotarians and guests in attendance. It combined wonderful fellowship, outstanding entertainment and very active plenary sessions. The R.I. President’s Representative was Ralph McLaughlin of Big Spring, Texas. Also in attendance was R.I. President-elect Stan McCaffrey.

The conference adopted a new and revised set of resolutions prepared by Archivist Charlie Strobe. Recent years had seen certain inconsistencies develop since the original resolutions had been adopted.

Throughout the year Rube preached his “Possibility Thinking” theme and dared clubs to try bigger and better major service projects. Many outstanding major projects were reported on at the conference.

Rube and Rena led a group of local Rotarians on a tour to far away Sao Paulo and the International Convention which was attended by over 16,000 Rotarians and guests from 94 countries. There District 513 Past District Governor Stan McCaffrey was officially elected President of Rotary International for the year 1981-82.

PDG Bob Paroli again honored our district as he served as R.I. President’s Representative to District 561 in Pierre, South Dakota.

June 27 saw another District Assembly as Rube turned over the reins to Governor-elect Bob Rockwell after a year of which he deserved to be very proud.

## ROBERT R. ROCKWELL

1981-82

Robert R. (Bob) Rockwell probably felt particularly inspired during his year in office since his former fellow San Francisco club member, Stan McCaffrey — also a District 513 Past District Governor, was serving this year as President of Rotary International.

Bob grew up in Long Beach and San Diego. He graduated from the University of Southern California and served as a company commander in the U.S. Marines in the Pacific during World War II. He served with the F.B.I. at a number of stations and was a member of several Rotary clubs, serving as president of the club of Coeur d'Alene, Idaho. After retiring from the F.B.I. he served with Burns Security Service and became active in the San Francisco club, and was soon recognized as editor of their outstanding club bulletin, "Grindings". Bob and his wife Jeanne have five children. He is active in security trade associations and performs consulting service in that field.



Stan McCaffrey's theme was "World Understanding and Peace Through Rotary". His belief was that the almost one million Rotarians around the world should have some measurable influence in the way things work and the way people get together. With Rotarians on both sides of the borders of many trouble spots of the world, Rotarians are a source for peace and goodwill. He conducted "Conferences on Goodwill" in eight such places in the world. President Stan also encouraged the recognition of women who had been part of Rotary club projects.

During his year as District Governor, Bob urged his clubs to pursue that theme and each club was asked to conduct an international project during the year. World Understanding Week was celebrated February 21-27, 1982.

Bob urged greater involvement and financial support for the Rotary Foundation while announcing that last year's contribution finally came to \$132,089.60 — a new record. On the basis of this amount the district became a 2600% plateau contributor and became eligible for five Foundation awards next year.

PDG Al Quilici was appointed by President Stan to the R.I. World Fellowship Activities Committee.

District Youth Exchange Chairman Dave Dillon kept busy with another fine year of exchanges of young people with other countries.

The Rotary Club of San Rafael East was chartered on March 27, 1982 with 30 members. This club was later to change its name to "Mission San Rafael".

A group of Interact members visited the Bay Area from District 269 of Japan.

This was a year of rain and floods and clubs were able to assist communities which suffered losses.

Rotary International again placed a float in the Rose Parade. Its international message of goodwill was seen by all the country.

A dinner honoring R.I. President Stan McCaffrey was held in San Francisco January 5, 1982. It was attended by Rotarians from other neighboring districts as well as District 513 members.

The Presidents-elect Training Seminar was held February 27-28, 1982 in Concord. As usual, attending presidents-elect were enthusiastic about its worth.

A well attended District Conference was held at Napa's Silverado April 20 - May 2, 1982. With 390 Rotarians and 239 guests in attendance, there was excellent participation in the well-planned plenary sessions. Meanwhile fine fellowship was enjoyed in the beautiful conference facility.

A Group Study Exchange team was received from England's District 122 from April 2 to May 7. They visited clubs throughout the district and were a feature of the District Conference. Meanwhile a group from District 513 was selected to visit England next fall and they too appeared at the conference.

By resolution the per-capita contribution was increased from \$7.50 to \$8.50. PDG Bob Paroli was selected to be the district's representative to the R.I. Council on Legislation next year. The R.I. President's Representative to the District Conference was Rajendra Saboo of India.

Clifton C. (Clif) McGarr of the Rotary Club of San Rafael was selected as District Governor-nominee for 1983-84.

The Rotary Clubs of Sausalito and Novato each achieved the 10,000% Rotary Foundation Plateau and were recognized with a special award by R.I. At this time there are only 49 such clubs in the world with this status and two of them are in District 513!

The International Convention was held in Dallas, Texas.

The District Assembly was held at Santa Rosa Junior College on June 26, 1982.

The year saw a net gain of 129 Rotarians plus one new club of 30 members in the district which Bob had served well.



## RICHARD L. KEITH

1982-83

Richard L. (Dick) Keith grew up in Chicago, Illinois and studied architectural engineering at the University of Illinois and Illinois Institute of Technology where he graduated with a degree in civil engineering. He was a paratrooper during the Korean War.

A registered civil and structural engineer in most of the western states as well as Alaska and New York, his firm of Keith and Associates has had projects from Sydney, Australia to Toronto, Canada. He has also served as guest lecturer on winery design at seminars across the country.

Originally a member of the Sonoma Valley club, he became a member of the West Santa Rosa club in 1968 and became its president in 1973-74. A Paul Harris Fellow, he served as Area Representative under District Governor Rube Kaehler. He and his wife Elaine have two children.

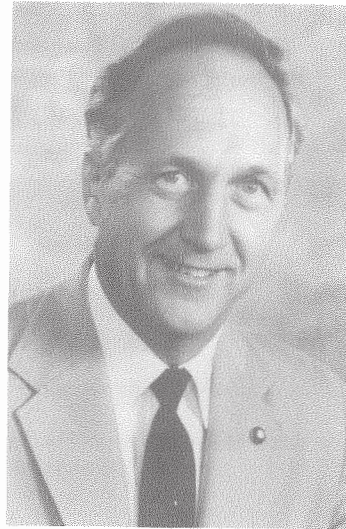

Rotary International President Hiroji Mukasa of Japan adopted the theme "Mankind is One - Build Bridges of Friendship Throughout the World". Understandably, this theme was quickly accepted by civil engineer Governor Dick as he led District 513 this year. In particular it was his intent to help build bridges of friendship with special emphasis on a year for youth. As he noted early in his year, "If we begin now working with young people who will lead the world tomorrow, we have a realistic chance at achieving our goals."

His newsletters "Richard's Almanack" communicated Rotary information, plans for the district activities along with appropriate words of wisdom by Benjamin Franklin. A regular feature of the newsletter was a column about various outstanding projects being performed by clubs throughout the district. No doubt the most outstanding one was "Rotary Manor" — a senior citizen apartment complex built by the Rotary Club of San Rafael. Taking over an abandoned school building, they completed this fine facility without any government assistance. An open house was held there the night before the year's District Assembly.

The District 513 Group Study Exchange Team, led by Rotarian Frank Hedley of San Bruno, left for District 122 in England during the fall. They were later to appear at the District Conference where they entertained the crowd with stories of their trip.

R.I. Director Mike Kutsuris spoke at the Sonoma County meeting of Presidents and Secretaries. He talked about the role of Rotary in the world today.

Once again it was noted that District 513 during the year 1981-82 had surpassed itself in contributions to the Rotary Foundation with a final total of \$169,356. This made the district a 3100% plateau contributor.

The program "Rotarians for Running and Fitness" was promoted throughout the district and again a float with the Rotary theme was part of the Rose Parade as various districts supported the effort.

District 513 lost its then oldest living PDG when Charlie Wheeler died after a long lifetime of service. He was District Governor in 1937-38 and President of R.I. in 1943-44.

Another President-elect Training Seminar was held February 26-27 1983 at Concord with Past President of R.I. Stan McCaffrey a featured speaker.

The Rotary Club of Cloverdale chartered a new Interact Club during the year and an Interact Conference was held March 5, 1983 at Piner High School in Santa Rosa.

Larry Myers of the Rotary Club of South Ukiah was selected by the Nominating Committee as District Governor-nominee for 1984-85.

A totally dedicated committee of West Santa Rosa Rotarians organized and conducted an excellent District Conference at the MGM Grand at Reno. Well attended, it combined fun, fellowship and worthwhile Rotary information. PDG James Vanderburg was the R.I. President's Representative.

A special feature at the conference was speaker Russell (Rusty) Schweickart, Apollo 9 astronaut. His message "No Frames - No Boundaries" described his view of the earth from outer space which gave him a personal insight into the meaning of "Mankind is One". An additional feature was the appearance of a fine group of young entertainers, The Young Ambassadors.

Bob Paroli reported on the action taken at the Council on Legislation held in Monaco where he represented our district.

Several resolutions were considered at the conference. One removed surplus funds from the district operating funds and placed them in the hands of the Finance Committee. A long-standing question about eliminating the alternating north/south District Governor selection was left unchanged.

The International Convention was held in Toronto, Canada.

A new Rotary Club became official as of June 10, 1983 when the Mid San Mateo County Club was approved as our 55th club. Charter night ceremonies will be in August. In addition to the new club, again the membership of District 513 increased (as contrasted with a troubling stagnation of membership in most other parts of the world).

June 25, 1983 saw a fine District Assembly at Indian Valley College where Governor Dick spoke his farewells after what by all standards was a fine year of service to District 513 and Rotary International.

## CLIFTON C. McGARR

1983-84



Clifton C. (Clif) McGarr received his District Governor's pin from Dick Keith under the oaks at Indian Valley Colleges in Ignacio during the District Assembly. That fine day, filled with sunshine, was to foretell a happy, cheerful, but very productive year of Rotary for Clif and his vivacious Rotary Ann Ellie. Taking the job seriously, he sold his business when he was chosen as governor so that he might give full attention to the job.

Clif was formerly president and general manager of Rice Supply, Inc., a floor covering and building materials wholesaler with warehouses located in San Rafael and Eureka. With that firm since 1945, he is a native Californian born in Woodland in 1919. He served as a medical supply officer 1941-1945 at Hamilton Air Force Base in Novato and was separated with the rank of Major.

Clif joined the San Rafael club in 1955 and served as club president in 1973-74. He was the District Governor's Area Representative in 1978-79.

Clif and Ellie have four children and three grandchildren. Active in community affairs, he has been a director for the Marin Chamber of Commerce, Ross General Hospital and Nazareth House. Next to Rotary, his favorite hobby is fly fishing.

Rotary International President William E. (Bill) Skelton's theme was "Share Rotary - Serve People". Bill emphasized Rotary membership growth as he said, "Men need Rotary and Rotary needs more men." Answering that challenge was the first of Clif's goals and the district realized a net gain of 95 members during the year.

The West Santa Rosa club, under the chairmanship of Pete Hoogland, established a sister club relationship with Heerhugowaard-Langedijk in Holland. Seven Dutch young people came to visit the Santa Rosa area to establish new bonds of friendship. Next year seven West Santa Rosa youngsters will go to Holland.

The 1982-83 year's contribution to the Rotary Foundation was finally reported to be \$191,876 or \$47.09 per capita. This was the 13th highest contribution in the world, making 513 the number three district in Region 1.

District 513 suffered the loss of PDG Harry Empey in October. All who knew Harry agreed that his lifetime was dedicated to service above self.

The new San Mateo club — first called "Mid San Mateo County" — later changed to "San Mateo Evening" — was presented with its charter August 2. Thus District 513 grew to 55 clubs.

Certainly a high point of the year was a project which benefited the Rotary Foundation. PDG Bob Paroli, long involved in Foundation matters, went to considerable effort to arrange for a special program. Past R.I. President Clem Renouf was the keynote speaker at a dinner in San Rafael. \$50 tickets to the affair were sold (\$35 of which went to the Foundation); \$10 drawing tickets were also sold at all the district clubs. The drawing included some unusual and valuable prizes. A total of \$95,000 was netted with 39 new Paul Harris Fellows and 274 new Paul Harris Sustaining Members in the 51 clubs that participated. It was a fun way in which to assist the Foundation. The district to date this year has contributed over \$280,000 which translates to eligibility for 15 scholarship awards next year.

A new, comprehensive district awards program was developed which provided recognition to a broad spectrum of club efforts during the year.

The Petaluma club held an international dinner dance honoring some 25 high school foreign exchange students who were attending Petaluma high school.

19 clubs received the new Presidential Citation award for the year. They were Arcata, Crescent City, Cloverdale, Mad River, Millbrae, Mill Valley, Mission San Rafael, Napa, North Napa, Petaluma Valley, Redwood City, Rohnert Park/Cotati, Ross Valley, San Francisco, San Mateo Evening, Sebastopol, Sonoma Valley, San Rafael and Southwest Eureka.



PDG Dick Keith moved from District 513 within weeks after leaving office and so was unable to fill the routine district committee chairmanships as designated by district resolution. With the previous loss of PDG Harry Empey there were some substantial changes in leadership of the Finance and Nominating committees for the year. Bob Paroli was chairman of the nominating committee for 1983-84 and Art Agnew will repeat the job in 1984-85 with Paroli to follow him again in 1985-86.

The outstanding performance in the avenue of club service during the year was what was to become known as the "Miracle of Mad River". For several years the Mad River Club had struggled along with as few as 17 members (that was the number at the beginning of this year). One man with a cause was this year's Mad River president, Sam Merryman, who planned to make that club something of which to be proud. The year end saw that club's membership tripled to 51 and the winner of several awards for its accomplishments during the year.

The Eureka club adopted a major program of sponsoring a 12-bed residential treatment facility for young people between the ages of 14 and 18 years. To be initially capitalized at \$125,000, it will accommodate youngsters whose only alternative for placement might be the California Youth Authority or juvenile facilities.

The Napa club sponsored a new project. Some 400 Rotarians attended their fly-in with guest speaker WWII and Korean ace Marine Colonel Greg (Pappy) Boyington.

A major anniversary was the 75th birthday of the Rotary Club of San Francisco. In recognition of the occasion the club decided to exceed their usual sizable contribution to San Francisco charitable and educational organizations. Among other projects they donated \$100,000 worth of computers to the San Francisco schools and committed their support for a needed bridge at the Mendocino Camp for the S.F. Boy's Club. Special proclamations honoring the club for 75 years of community service were presented by S.F. Mayor Feinstein and State Senator Milton Marks. A grand dinner dance was attended by Past R.I. President Stan McCafrey.

The San Francisco club observed Rotary Foundation month by having a special \$100 Foundation table at one of their meetings. The result was ten new Paul Harris Fellows and thirty new Sustaining Members. Over \$10,000 was raised.

Monthly attendance for the year averaged 87.76 %.

Novato's Nova-Ro II, the club's second senior citizen low rent housing project was announced as underway. Located on seven acres, it will contain 57 apartment units.

Norman T. (Norm) Lawrence was nominated to be District Governor 1985-86. Norm was charter president of the Ignacio club and was District Governor's Area Representative in 1980-81. Ed Cadman, of Wenatchee, Washington was elected President of R.I. for year 1985-86.

The annual District Conference was held April 26-29 at Concord. Excellent facilities and a well-planned program made it a totally successful affair.

June 29-30 saw a record turnout for the Annual District Assembly at Ukiah. 250 attended a gathering Friday night and in excess of 600 attended the Saturday sessions.

A good number of District 513 Rotarians attended the International Convention at Birmingham, England.

The district received a group of young business and professional men from District 910 which is made up of 26 clubs in the African countries of Benin, Gambia, Ghana, Ivory Coast, Liberia, Mali, Mauritania, Niger Senegal, Sierra Leone and Toga. The program was sponsored by trustees of the Rotary Foundation and the U.S. Development Exchange.

In a final newsletter column Clif observed: "I can look back at 35 years in business and say, 'That was great.' But I can look back at a year as Rotary District Governor and say: 'That was the top of the mountain.'"

"I saw a need and wanted to do it full time", he recalls. He viewed the governor's role as one of finding opportunities for change, particularly at clubs which may be languishing — then pushing and getting them to move on and reach higher.

## LARRY D. MYERS

1984-85

Born May 28, 1939, Larry had to be among our very youngest District Governors when he assumed the position in 1984 at age 45. A charter member of the South Ukiah club, he served as its president in 1977-78 and his involvement caused him to be recognized as Rotarian of the Year in that club in 1981. Deeply committed to Rotary, he served in a wide area of community and Rotary duties in his club and district committees. He owned and operated a pharmacy in Ukiah where he lived with his wife Jill and two children.

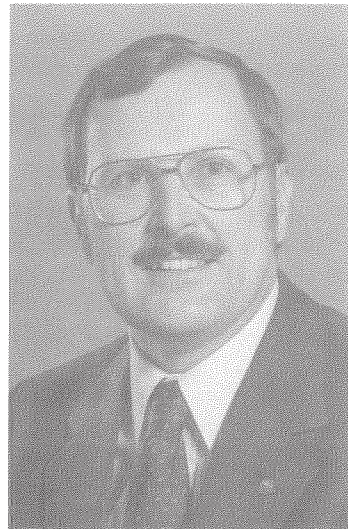

With 588 registrants in attendance at the district assembly in Ukiah's excellent high school facility on a beautiful, sunny day, Larry stated his support of incoming R.I. President Carlos Conesco's theme of "Discover a New World of Service". His year to follow opened that new world with a particular emphasis upon the Rotary Foundation. He clearly communicated his personal interest in the Polio 2005 campaign which would undertake the ambitious plan to immunize all the children of the world against the dread disease of polio by the year 2005—the 100th anniversary of Rotary.

Larry was pleased to commend the work of the Novato club in expanding upon the NovaRo Senior Housing project. He introduced the Presidential Citation program which gave special recognition to clubs which accomplished certain goals in the way of Rotary growth and program development. Eventually 38 clubs qualified for the honor. In addition to many other club projects completed during the year: Willits constructed a new soccer field, complete with fence, well and sprinkler system; South Ukiah carried out a "Wheels for Handicapped" project which saw golf carts refitted for street use; San Francisco supported the Police Athletic Leagues in the city; Christmas food programs were provided by Tiburon and San Bruno clubs; San Bruno's Earthquake Ball benefit; Tiburon-Belvedere's support of the Marin Suicide Prevention Center and the Boys and Girls Club of Marin; San Francisco spent \$50,000 on a bridge over the river at a previously divided Camp Mendocino; Mendocino's support of the Kelley House, Glorianna Opera Company and Mendocino Art Center; West Santa Rosa's Christmas party for underprivileged children; Mill Valley's assistance of an eye clinic in India; both Rohnert Park-Cotati and Belmont sponsored new Rotaract Clubs while Belmont held their first Career Day involving over 100 students; St. Helena supported the Child Assault Prevention Program in their community; Santa Rosa not only promoted a special tabloid newspaper to be used for public service efforts but won a merit award from the city for their Symposium on Hiring the Handicapped; Mission San Rafael completed a highly successful program called "Share a Profession with a Student"; Guerneville's Russian River canoe trip; Eureka gave a big support to the United Way while also instituting plans for a drug and counselling center for youth in their area; Napa's Fly-in with speakers Jeanna Yeager and Dick Rutan of the great Voyager non-stop flight around the world; Several clubs engaged in exchanges with sister clubs in foreign lands.

Larry's own South Ukiah club established a high standard of support for the Rotary Foundation when 100% of its members became either Paul Harris Fellows or Sustaining Members. Later the Mission San Rafael and Petaluma Valley clubs would join this select group.

President Carlos Conesco issued a challenge to Rotary clubs to reach a total of one million members throughout the world. Larry pushed this effort as he encouraged his district to account for their share of that growth and as a result there were 134 additional Rotarians by the year's end.

Larry attended a three day Mexico-USA Goodwill Conference in Guadalajara. Later in the year Larry led a number of District 513 Rotarians in attending an evening Fiesta with R.I. President Carlos Conesco at the Monterey Conference Center. Plans were made for a Group Study Exchange with Paris, France District 166.

After years of effort by previous District Governors of District 513, a second club was at last chartered in San Francisco. PDG Bob Rockwell was the special representative for Governor Larry as the Stonestown Club (a few years later to be renamed "San Francisco West") was organized in the Stonestown Shopping area. In addition the Rotary club of Middletown was formed with the help of Clearlake Rotarian Charlie Bushman. Another Marin club (eventually named Marin Evening) was chartered on May 23. Warren Glass of Sausalito served as Governor's Representative. On June 25 the new Redwood Shores club with Sid Berlin of Redwood City as Representative was chartered. Thus Larry's year saw four new clubs added to the district.

The annual Rotary Foundation Dinner raised \$140,488.50 as it featured speaker R.I. President-elect 1984-85 M.A.T. Caparas. District 513 was to go on to become the number three contributor to the Rotary Foundation in the entire world. Perhaps no program better exemplifies Rotary's efforts to serve others than the Foundation, and perhaps no other district has proven itself so able to unselfishly "Discover a New World of Service" this year than District 513 with its enormously successful Foundation Dinner. For the first time the District donated one of its Foundation Fellowships to a third world nation as a student from District 327 of Pakistan was able to attend Humboldt State University in Arcata.

A District Interact conference was held April 26-27 in Ukiah. Through Interact the principles of Rotary were introduced to many young people in the district.

Rotary's 80th birthday was celebrated by clubs throughout the district. The International Convention was held in Kansas City, Missouri.

806 people attended a highly successful district conference in Ukiah. The theme of this gathering could well have rested in the cooperation between clubs in Governor Larry's immediate area. Lakeport, Clearlake, Willits, Ukiah and Fort Bragg all pitched in to assist the South Ukiah club in details of the conference. Bill Nystrom, Director-elect of R.I. was the R.I. President's personal representative. Particularly outstanding were the special ladies' events. Once again these were organized by local club ladies. This sort of cooperative effort minimized expenses to the extent that Larry was able to leave a \$10,000 treasury balance when he left office. Sidney Berlin of the Redwood City club was selected as District Governor for the year 1986-87. Distinguished Service Awards were made to Dave Dillon, Larry Mobely and Jack Vallergera.

After a fine Rotary year, Larry surprised nobody by choosing not to take what could certainly be called a well-earned rest, but rather accepted the responsibility of heading up the Polio 2005 program (later to become PolioPlus) during the following year. His great contribution to Rotary and District 513 was thus to continue.



## NORMAN LAWRENCE

1985-86

Retired Air Force Colonel Norm Lawrence once served as Commander of a Tactical Airlift Wing and Vice Commander of the Nineteenth Air Force. He brought that leadership and administrative ability with him when he assumed the Governorship of District 513. A native of Pennsylvania and a graduate of Syracuse University, he served in the United States Air Force for 31 years, flying in combat operations in World War II, the Korean War and in Vietnam. Following retirement from the U.S. Air Force, he was employed in the finance industry with Home Savings of America as Vice President and Manager of a branch in Marin County for 11 years. A Rotarian since 1973, Norm was the charter president of the Rotary Club of Ignacio 1976-77. He and his wife Claudia resided in Novato during his incumbency. They have three sons.

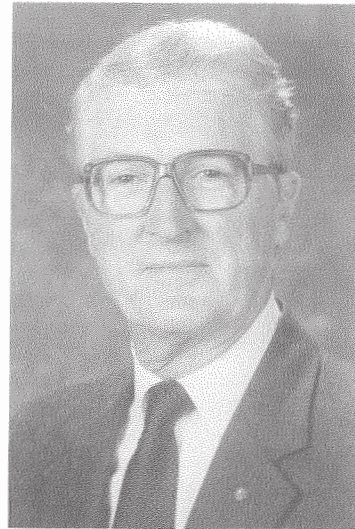

During the annual District Assembly at Indian Valley College in Novato with over 400 Rotarians in attendance, Norm was charged with the leadership of District 513. His Rotary International President Edward Cadman delivered this message to Norm: "The foundation, the strength, and the goodness of Rotary is in the individual Rotarian. He is the key to Rotary's growth and service". Norm's challenge was to make sure that every Rotarian in the District understood that "You Are the Key". His monthly newsletter expounded upon this theme and to assist in its promotion coined a supporting theme "Carrying The Torch for Rotary".

Norm was intent on making the Rotarians of the district aware of the "internationality" of Rotary. As he candidly put it "Get out of your sandbox". This point was emphasized on his club visitations to the 59 clubs that were in the District during that year.

The 2nd annual Rotary Foundation gala dinner, chaired by PDG Clif McGarr of San Rafael, was held on 2 November. Keynote speaker was Cliff Dochterman of Stockton, past Vice-President of Rotary International. Over \$144,000 was generated by club contributions as part of the event, the largest sum gathered for a single event in R.I. history.

For the first time in our District history we saw *two* Group Study Exchange Team events take place. Group Study Exchange Committee Chairman Frank Hedley of San Bruno coordinated a visit of our Team to District 166 in France. Jim Hoff of Eureka was the Team Leader. Through R.I. Norm invited a GSE Team from District 265 in Japan to visit our District. This they did in May 1986. Because of a very successful visit earlier by a Youth Exchange Group from the same District to Menlo Park, together with the fine rapport developed during the GSE Team visit, a District Resolution was passed to declare our respective organizations as *Partner* Districts.

The Marin Evening Club and the Redwood Shores Club celebrated their entrance into Rotary with gala dinner affairs early in the Rotary year. These two clubs were formed by the previous District Governor. Norm brought in two clubs later, the San Mateo Sunrise Club and the Santa Rosa Sunrise Club. They too had delightful celebrations.

One of Norm's goals was to appreciably increase the membership of the District. Committee Chairman Jim Benoit of West Santa Rosa helped clubs focus on Norm's goal. The year end saw an increase of 152 new Rotarians.

Rotary International President Cadman accepted our invitation to be our honored guest on 3 January. Present were 700 Rotarians and their ladies gathered in Santa Rosa to receive President Ed and his wife, Mary Jean. The audience included past, present, and future District Governors. Also in attendance was R.I. Director Bill Nystrom along with a large number of Paul Harris Fellows. Dr. Cadman offered humor, news and inspiration as he brought the audience up to date on current Rotary activities while emphasizing the world wide work of Rotary.

Norm urged his clubs to assist in providing relief to the Mexico City area that was short of being totally destroyed by a severe earthquake. The clubs contributed over \$6,000 through Rotary channels to the people in that country to ease their suffering. Another catastrophic occurrence was the severe flood that almost destroyed Guerneville. Again the clubs in the District contributed money, household items and clothing to the people in that area.

The District was honored when several of its Past District Governors were selected to serve as personal representatives of the R.I. President in district conferences around the world. Charlie Strope of Eureka to Indiana, Art Agnew of Petaluma to San Diego, Bob Paroli of Menlo Park to Louisiana and Al Quilici of San Rafael to Italy and Denmark.

In keeping with Rotary International's commitment to eradicate Polio from the face of the earth through vaccinations, Norm asked each Rotarian of the District to contribute \$10.00 for that purpose. Polio Committee Chairman Larry Myers reported that the goal was exceeded by several thousand dollars.

Norm asked each club to have at least two on-going community projects and one international project accomplished during the 1985-86 Rotary year. The response was outstanding. The local projects exceeded the goal and most of the clubs became involved in international projects. Too numerous to cover, a few are cited for their extraordinary accomplishment: The Eureka clubs became deeply involved in the foreign youth exchange program with Dave Dillon leading the entire program for the District. The Eureka Club raised \$7500 for the Community Service Program. South San Francisco raised \$10,000 for the Boys and Girls club. Sebastopol raised \$14,000 for community projects; San Carlos conducted a very successful Dixieland Jazz Jamboree clearing over \$30,000 for various community projects; Burlingame began a fund raising drive to provide a new intercom system in the High School. \$33,750 was raised for this project.

Santa Rosa sponsored the First Annual Symposium of Employment for People with Disabilities; DG Norm's home club of Ignacio conducted a mini-olympics swim meet for over 3,000 children and gave them \$5,000. The Novato Club completed a 1.5 million dollar senior citizens apartment building consisting of 56 units. San Rafael started a 1.4 million dollar addition to the \$3,950,000 Rotary Manor senior citizens retirement complex. Rohnert Park-Cotati coordinated the shipment of 25,000 doses of donated medicine to Chile.

Interact Clubs were formed at Half Moon Bay and Santa Rosa, bringing the total in District 513 to 32 Interact Clubs. Redwood City started a new Rotaract Club at Canada College.

The International Convention was held in Las Vegas June 1-4 and was well attended by members from District 513. One of the highlights of the convention was when a Rotarian from France was identified as the one-millionth person to join Rotary. Edward Cadman the President of R.I. delivered one of the most motivating speeches in the history of Rotary. His theme "You are the Key" was very adroitly tied in with the PolioPlus program, the major humanitarian program of the year. Bob Paroli addressed the convention on our highly successful Foundation support efforts.

The district's Youth Exchange Program under the leadership of Dave Dillon of Eureka experienced a great year. A special gathering of those students was held in McKinleyville in July and later at DG Norm's District Conference where they gave an outstanding performance of their goals and objectives for the youth of the world.

Aldo Simonetti of the Rotary Club of Burlingame was selected as District Governor for the year of 1987-88. A seminar for the incoming club presidents was held at Concord in March.

A highly successful district conference was held in Santa Rosa June 12-15, a departure from the normal time frame because of conditions created by R.I. and other mitigating circumstances beyond the control of the District. The conference theme was "Carry the Torch for Rotary". Past R.I. President Hiroji Mukasa was the President's representative and was one of the speakers at the conference. Another speaker was General Robert Herres, Commander in Chief of the U.S. Space Command. The Group Study Exchange Team Chief recounted his team's experiences in France. The visiting GSE Team from Japan was introduced as were 35 Exchange students who performed admirably at the conference.

DG Norm in his "State of the District" address to the conference said nearly 100% of his 10 stated goals for 1985-86 were made. Membership was substantially increased, new clubs were formed, nearly all clubs had on-going community projects and many were involved in international projects. Almost all were involved in the student exchange program; many clubs became 100% Paul Harris Sustaining Members and the district raised over \$340,000 for the Rotary Foundation an all time high for the district. The goal of 90% overall attendance at the Club meetings was not quite attained but was a lot higher than other Rotary districts.

District Governor Norm can well be proud of a truly outstanding year of Rotary service to District 513 and the Rotary world. He truly was the district "Key" for the Rotary year of 1985-86.



## SIDNEY L. BERLIN

1986-87

Sid Berlin approached the task of governing District 513 with the same vigor that he had exercised in many previous assignments. His active legal career led him to the position of President of the San Mateo Trial Lawyers Association and Vice President of the state Trial Lawyers Association. He was president of the Rotary Club of Redwood City in 1981-82, Area Representative and District Parliamentarian. Meanwhile he served on the city planning commission, the Democratic Central Committee, Salvation Army and many other organizations.



Born in Detroit, Sid grew up in California, attended Cal State Fresno and received his law degree from the University of Santa Clara. He has a son and three daughters.

At various Rotary club meetings Governor Sid, in a clear and distinctive voice which rarely required amplification, delivered the theme of R.I. President M.A.T. Caparas, "Rotary Brings Hope". All the while he communicated his own personal message, a charge that clubs were not allowed to forget, "We're going to have a great year!"

A great year they had as Governor Sid promoted a series of very ambitious programs to be completed during the year. Some clubs in the district seemed overwhelmed by the magnitude of some of the projects, but Sid was able to communicate his commitment and perseverance such that the projects were ultimately completed successfully.

One such major plan was the 100% Foundation plan for District 513. Ted Kruttschnitt, a name not soon to be forgotten, past President of the Burlingame club, and his wife Cathy, in an extremely generous offer, agreed to put up \$50 for each of the more than 2,000 Rotarians of the District who had not started their Paul Harris Sustaining Membership—on the condition that each of the clubs match the donation. Ted's Gift of \$103,000 when matched by the district clubs raised well over \$200,000 for The Foundation. Successful completion of that project gave Governor Sid the honor and pleasure of personally taking a list of 2,000 new Paul Harris Sustaining Members back to R.I. headquarters. That amount plus the money raised at the two Paul Harris dinners and a special PolioPlus fundraising program headed by PDG Norm Lawrence came to a grand total of \$600,000.

A Group Study Exchange was made during the year as teams from District 432 in Chile visited here while simultaneously our group went to Chile in April 1987. A team was also selected to visit Japan. Chairman Frank Hedley of San Bruno directed the program. In addition plans were finalized for Group Study Exchanges with District 913 in Nigeria and District 992 in New Zealand during the year 1987-88.

Governor Sid started his visitations in the north and made good use of his own airplane to make those long trips considerably less time consuming. This allowed him to make more than the normal number of visits to district clubs.

Among the many club projects during the year: Santa Rosa supported their member Tom Farrell in a program to support the handicapped with a Symposium for Employment of People with Disabilities and a Barrier Awareness day; Only a month after chartering the Santa Rosa Sunrise Club started on their opening fundraiser, an Octoberfest; Guerneville's project to help provide smoke detectors for senior's homes; Belmont provided medical supplies to a club in Ecuador for a children's hospital there; the San Mateo Sunrise club declared war on drug abuse with a campaign designed to create public awareness and support; the San Carlos club sponsored its annual Dixieland Jazz Jamboree with proceeds going to the San Carlos Community Services Foundation; Burlingame "adopted" their local high school, providing the school with several new facilities; San Francisco adopted two world community service projects in the Philippines by disseminating nutrition information to one area and by a goat dispersal project among the needy people of another; Mendocino donated \$7,100 of its annual Art Auction proceeds to 17 organizations working in their area; the Eureka club completed its annual Clam Beach Run in Trinidad; the Ignacio club purchased a specially equipped \$24,000 nine passenger van for the Novato Human Needs Center; the Belmont club invested \$7,000 in a student Play It Safe program for children for their area.

The Ferndale club was honored by a mention in the Rotarians Magazine of their World Community Service project. Their "Project Amigo" supports orphans in the Mexican state of Colima.

August 23 saw the new San Mateo Sunrise club become a part of District 513. Frank Crupi of San Mateo served as the District Governor's Special Representative in forming the new club.



The District Scholarship Committee selected ten winners and five alternates out of 29 applicants for the year's Rotary Foundation scholarship awards. The large number of awards of course reflects the substantial contributions made by the district to the Foundation. Each unit of award represented \$21,000 in contributions the previous year.

A good number of District 513 Rotarians attended a special dinner in Stockton honoring R.I. President M.A.T. Caparas. MAT delivered a message about world community service and what it does to foster peace throughout the world.

An historic matter which came to a conclusion was the highly controversial issue of women in Rotary. Considered and voted down by the Council on Legislation each session since 1972, the matter came to a head when the Rotary International board of directors lifted the charter of the Duarte, California club which had chosen to admit women to membership. Progressively considered through the courts of California and eventually the U.S. Supreme Court, it was ultimately determined that the male only provision of Rotary membership could no longer be enforced at least in the state of California. The R.I. board meanwhile stated that they would not take action against clubs in other areas which chose to admit women. Even before the final decision by the U.S. Supreme Court several District 513 clubs had decided to admit women and by the end of Sid's year, more than forty women were in our district clubs and clearly more were on the way.

R.I. President M.A.T. Caparas encouraged all clubs to support the Tournament of Roses float which pictured the theme "Rotary Brings Hope."

Special honors came to the Novato club as their new NovaRo II Project was completed giving them 100 low cost rental units for seniors. At ceremonies in the White House Rose Garden on June 17 they received a President's Citation for Excellence in the Private Sector from President Reagan. Of the 100 or so awardees they were the only service club as they joined with such firms as BankAmerica Corporation, Westinghouse Broadcasting, IBM and others.

It was announced that the Rotary International project of ridding the world of polio by the year 2005 (the 100th anniversary of Rotary) was being advanced to a program called PolioPlus which would accomplish the task by 1990. Plans are to raise \$120 million throughout the Rotary world during the next three years. District 513's share of this sum was stated to be \$1,723,850, to be raised in the next three to five years, but by year's end clubs had pledged some \$2,282,500.

Governor Sid was asked to speak at the District 517 Conference in Palo Alto on the subject of fundraising for the Foundation. There was little need to ask why since the head of the Rotary Foundation fundraising activities call District 513 "one of the most preeminent districts in the Rotary World."

Under the leadership of District Chairman Clif McGarr, two highly successful Foundation Dinners were featured in November. One at Eureka and another in San Francisco. Eureka's gathering of 353 people featured guest speaker Herb Brown, Trustee of the Foundation; Dinner, Chairman John McCaddon, M.C. Charlie Strobe, PDG Bob Paroli, DGN Aldo Simonetti and of course Governor Sid. The San Francisco gathering saw 500 persons, led by M.C. Jim Patrick of San Francisco, heard an inspiring speech by former R.I. President Carlos Canseco. Others participating were Bob Paroli, William Conklin, Mike Dolan and Dick Miller. A total of over \$200,000 was raised at the two dinners.

The Rotary Club of Gualala, about 50 miles south of Mendocino, was formed. John Hilt served as liaison between Mendocino and the Gualala club and became its first president. Ed Schleiger of the Mendocino club did a great job in helping get the new club started. When Governor Sid handed the gavel to charter President Ken Kuykendall, the Rotary club of Larkspur Landing became a part of the district.

It was noted that R.I. has moved into new and larger quarters with the purchase of One American Plaza in downtown Evanston. Prior to this date they were spread over three locations.

The 1987 District Conference served to climax the Rotary year. There were a record 976 registrants including 588 Rotarians. Mel Spowart of British Columbia was the R.I. President's personal representative. Dr. Joseph Serra of Stockton presented a talk and slide presentation about the Rotary Foundation work being done in Malawi. The Chilean Group Study Exchange Team led by Frank Hedley of San Bruno was in attendance as well as a huge number of exchange students directed by Dave Dillon of Eureka and John McCaddon of Southwest Eureka. Chaired by Roy Frank, home hospitality at Rotary homes was a special attraction one evening. Bob Kane, a founding member of the Tiburon-Belvedere club, was selected as District Governor Nominee for the year 1988-89. Two resolutions, in increase of \$1.50 to \$10.00 in the per capita contribution and a mandatory group liability insurance fee of \$1.88 per member were passed.

A large representation of District 513 Rotarians attended the International Convention in Munich. Governor Sid, PDGs Bob Paroli, and Al Quilici participated in conducting the big Annual California Breakfast.

The District Assembly was conducted at Santa Rosa Junior College where Governor Sid received plaudits for what was indeed "A Great Year".

## ALDO J. SIMONETTI

1987-88

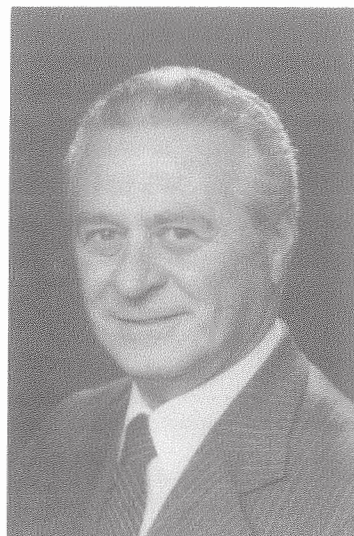

Personable, good-natured Aldo Simonetti let it be known that his year was going to be "Magnifico" as he prepared to pursue R.I. President Charles E. "Chuck" Keller's theme for the year: "Rotarians: United in Service—Dedicated to Peace".

A San Francisco native, Aldo joined Bank of America as a messenger and rose to Vice President and Manager of the Burlingame office before he retired in 1984. He served in the U.S. Navy in the Pacific during World War II and married Margaret in 1948. They have four children, eight grandchildren and two great-grandchildren. Aldo served his community as chairman of the Golden Gate Chapter American Red Cross; Director of Daly City Chamber of Commerce; Daly City Redevelopment Project; Burlingame Safety and Parking Commission.

His Rotary service included president of the Daly City Club in 1977-78; Peninsula Rotary Council Treasurer; Daly City Club Treasurer and Area Representative for District Governor Bob Paroli in 1978-79.

July 1987 saw 1,034,387 Rotarians in 22,901 clubs in 161 countries. District 513 had grown to 64 clubs—large not only in clubs and membership but geographically such that it was felt by many that qualified and capable candidates for the office of district governor were being discouraged. While adjacent districts were not interested in participating in a redistricting effort, Governor Aldo appointed a committee to seriously review our own prospects. The committee included PDG Sid Berlin, Chr., Redwood City; PDG Art Agnew, Petaluma; Frank Hedley, San Bruno; PDG Bob Paroli, Menlo Park; Eddie Payne, Crescent City; PDG Al Quilici, San Rafael and PDG Charlie Strobe, Eureka. This committee met on August 22 and decided to request redistricting with the division at the Marin-Sonoma County lines. The request was later approved by R.I. to take effect July 1, 1989 with the northern district keeping the identification of 513 while the southern district was assigned a new number—515. Of course, this required the nomination and selection of two District Governor Nominees. They were Jack Vallerga of Santa Rosa East for the northern District 513 and Bill Sturgeon of San Francisco for the new District 515.

PDG Rube Kaehler (1980-81) passed away in June.

The district goal of \$2,282,500 for PolioPlus was the third highest in the United States. Meanwhile efforts were being made to overcome the possible neglect of the other programs of the Rotary Foundation.

The West Santa Rosa club donated \$6500 to the Drug Abuse Alternative Center allowing it to establish a comprehensive drug abuse related videotape library.

Another new club was welcomed to the district on September 22 as Santa Rosa sponsored the Windsor club with its 30 charter members. On March 21 still another new club was chartered as the Peninsula Sunrise club bringing the number of clubs to 65.

The R.I. Board agreed to continue the Rotary Friendship Exchange and a committee was established to execute the program in District 513.

In support of PolioPlus Rotary Foundation dinners were held in Burlingame where past R.I. Director Mike Pedrick was the speaker and in Eureka where Richard Henning addressed a good crowd. A highly successful Biathlon saw Rotarians run or cycle 3450 miles and raise more than \$32,000 throughout the district. A golf tournament in Mendocino raised more than \$1200. South Ukiah manned a booth at the Redwood Empire Fair. An estimated 4000 people attended the Dixieland Jazz Jamboree at the San Mateo County Fairgrounds sponsored by the San Carlos club. The club with an assigned goal of \$50,000, but raised \$157,000! Mad River conducted an auction of valuable items over the local radio station. Cloverdale members lost 122 pounds to support pledges as they weighed in at the local feed store. Ignacio sponsored a Monte Carlo Night and raised \$12,000. Southwest Eureka raffled off a classic restored Mustang automobile.

The Presidents Executive Training Seminar was conducted in March in Concord. To provide more knowledge about Rotary, a special seminar was conducted February 20 at Santa Rosa. PDG Thomas Clayton from District 522 served as counselor.



A Group Study Exchange Team from New Zealand visited District 513 and attended the District Conference. Meanwhile the first-ever woman leader of a team was Shirley Olea of the Half Moon Bay club. Our team went to New Zealand in March.

PDG Rick King of neighboring District 517 was selected as R.I. Director for Zones 1/7. Rick had spoken at several 513 clubs in support of PolioPlus.

West Santa Rosa raised \$15,000 with a crab feed and dance attended by over 400. The Napa clubs again hosted their annual fly-in. The Tiburon-Belvedere club raised \$7,000 at its annual domino tournament. Rohnert Park-Cotati held its annual "Suitcase Night." Petaluma held its 34th annual Local Charities All Day Breakfast. Sebastopol planted 50 redwood trees at Ragel Ranch Park.

Petaluma Valley formed an Interact Club. Millbrae provided medical supplies and equipment to a needy hospital in Nigeria. West Santa Rosa conducted a career day at Strawberry High School.

A genuine "first" was the district's first pregnant Rotarian—Lenore Katri of Healdsburg. An additional unusual item of news was the marriage of Rotarians Mike Merrill of West Santa Rosa and Maureen McDaniels of Windsor.

A Eureka Rotarian documented that Humboldt County has 5.07 Rotarians per thousand population while the district average is 2.07.

Once again Chairman Dave Dillon and his student exchange committee were responsible for a busy year of exchanges with clubs in other parts of the world. Rotaract club members from District 260 and 276 visited our district. Eleven Rotary Foundation Scholarship winners were announced.

The R.I. Board of Directors announced that it was offering for consideration at the 1989 Council on Legislation, a proposed enactment to eliminate the word "male" from the provision for Rotary membership. The San Francisco club initiated a project that would provide scholarships, transportation and hospitality to five South African students as they study at USF. A West Santa Rosa crab feed raised \$7500 for the Sonoma County Coalition Against Hunger. Redwood City distributed booklets about the AIDS problem in the local schools. Cloverdale contributed to Sonoma County's Adult Literacy Program. Eureka sponsored students to the California State Science Fair in Los Angeles. Fort Bragg sponsored the fourth annual Invitational Baseball Tournament. Foster City/Mariner's Island sponsored a Monte Carlo night. Healdsburg sent two students to the High School World Affairs Seminar in Wisconsin. San Mateo Sunrise sponsored the San Mateo County All-Star Football Classic. Terra Linda supported an alcohol and drug free graduation night at the local schools.

April 16 saw the District Assembly at the Golden Gate Baptist Theological Seminary in Mill Valley. A month later, May 12-15, the District Conference was held at Konocti on Clear Lake. The R.I. President's Representative was PDG R. Clinton Emery of District 712 in New York. The weather failed to cooperate as the golf tournament was played in a hail storm. Governor Aldo was elected by the clubs to represent the district at next year's Council on Legislation in Singapore.

It was reported that from an original request for PolioPlus pledges of \$120 million from around the world, \$219 million had been pledged.

The International Convention was held in Philadelphia and 16,316 Rotarians and guests from 102 countries attended. Of that number 10,065 were from the United States. Among them were a good many from District 513.

The end of the Rotary year saw a tired but still enthusiastic Governor Aldo looking back upon a year of activity in District 513 about which he could be justly proud.



## ROBERT V. KANE

1988-89

With almost military precision Bob Kane put his life into Rotary. R.I. President Royce Abbey had announced as his theme for the year: "Put Life into Rotary—Your Life" and Bob wasted no time in doing just that. He also learned to stress that Rotary is an action oriented organization—that Rotary is what Rotary does—and that clubs can put life into Rotary by creating opportunities for each Rotarian to participate in a significant project in a Rotary Avenue of Service. He was of course the last Governor of District 513 as its territory has been defined since 1970. The following year would see a smaller district north of the Marin/Sonoma County line with the other half of the old district called 515.

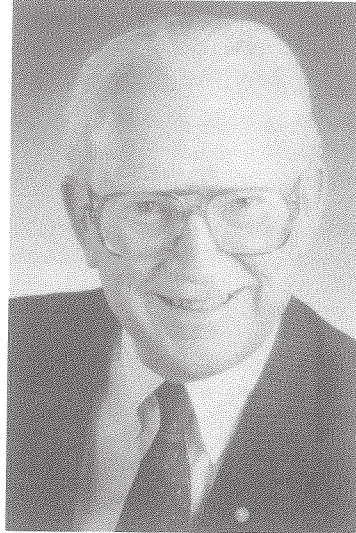

In 1975 Bob retired from the U.S. Army as Commanding Officer of the Presidio of San Francisco. Choosing an active retirement, he founded Presidio Press, a preeminent publisher of military books. He is married to Edie; they have ten children and twelve grandchildren.

Bob was a charter member of the Tiburon/Belvedere club and served as its president in 1980-81. He served as Area Rep in 1982-83 and was Chairman of the district Rotaract Committee for two years.

Bob began his eventful year by visiting the Novato club on July 8th. The visitation schedule took Bob and Edie all over the district from Menlo Park to Crescent City. They spent two weeks in Eureka, visiting seven clubs and learning about the splendid activities happening in the far north. That was their longest sojourn in one place, with others a single night to five nights. They were struck by both the beauty of this great state and the friendliness of the Rotarians they met. Their last visit was to the new Windsor club on December 13th. They weren't ready to start over, but they wouldn't trade anything for the wonderful experience of visiting the super clubs of District 513.

In September the San Carlos club again conducted its successful Dixieland Jazz Jamboree at the San Mateo County Fairgrounds joined by other San Mateo County clubs. The Foster City club conducted its annual "Halloween Safe streets" program by sponsoring a party in a cordoned off section of the city streets. With Governor Bob assisting, eight Paul Harris Fellow awards were made at one meeting of the Millbrae club. The Terra Linda club revamped a building for autistic children of Marin County. Funded almost entirely by donated funds, material and labor, they provided a facility in which these youngsters can be observed and helped. The San Francisco club organized and supported the first San Francisco Academic Decathlon, a program which places the same emphasis upon academic performance as normally given to sports. The program was conducted within the public high schools of San Francisco and this year it will be repeated with private high schools added to the competition. District Rotarians John Campbell (San Rafael) and Bernie Faibish (Ross Valley) joined a medical assistance team that visited Guatemala. They performed eye surgery and examination in that remote area. Southwest Eureka's raffle of a restored 1966 Mustang raised \$11,000 for PolioPlus. R.I. President Royce Abbey sent congratulations to the Half Moon Bay club and their medical team which went to Colonet, Mexico. Five Rotarians spent three days providing medical and dental care to some 600 villagers of the country. The Mission San Rafael club has for several years donated turkeys to the Canal Community Alliance of Marin County. This has assured that the disadvantaged of the area could enjoy tasty and nutritious holiday meals. Clubs of the district responded to Governor Bob's appeal for contributions toward the relief of people in Armenia who suffered from the results of a huge earthquake there with about \$4000 contributed. The Napa club, in conjunction with the Peace Corps, completed a school in Central America. Projects by San Francisco in Fiji, the Philippines, Argentina, Peru and Brazil provided medical equipment and service to children in those parts of the world. A group of Sebastopol Rotarians visited their sister club in Puerto Vallarta, Mexico to participate in a three-day celebration of Rotary. While there, they visited a poor village where the two sister clubs are working to bring water and sewage treatment to a local school.

Two new breakfast clubs joined the district during the year. The Old Town Eureka club was chartered under the leadership of the Southwest Eureka club with John McCaddon as the Governor's special representative. Later the Napa Sunrise club was chartered with the help of the Napa club. This brought the district's club total to 67 with 4784 members. 36 of those clubs are within the territory of the new northern District 513 while the other 31 will make up the new District 515.

The October newsletter noted that three clubs (Gualala, Old Town Eureka and Southwest Eureka) had perfect attendance months during September.

On October 15th a Rotary Foundation Benefit Dinner was held at the Marin Civic Center for those clubs in the southern part of the district. The affair was a dinner dance without speakers or business conducted. In addition November 12 saw a highly successful Foundation Dinner for the northern clubs at Eureka. The speaker was R.I. Past Vice-President Cliff Dochterman.

District Rotaract Chairman Frank O'Neill announced that two new Rotaract clubs had been formed. One is associated with San Mateo Community College and the other with Golden Gate University. The South San Francisco club announced that a new Interact club was formed at South San Francisco High School.

District 513 was honored when Tania Bocchi, an exchange student from Brazil sponsored by the Eureka club, was selected to be one of four young ladies invited to ride the 1989 Rotary float in the Rose Parade.

PDG Sid Berlin reported on Project Eye Camp conducted during September in Nigeria. A team of ophthalmologists performed 213 surgical procedures to remove cataracts; examined 869 patients and fitted 747 pairs of glasses. The dentist saw 231 patients. For a total expenditure of \$28,000 they bought medical equipment and supplies worth \$250,000 and left them in Nigeria. They taught local surgeons how to use the three binocular microscopes that were part of the equipment. It was a shining example of Rotary service.

During the summer the district had exchanges of young people with District 207 of Italy. The program was arranged by Chairman David Dillon of Eureka. This was only part of the year's extensive student exchange program which provided a wonderful opportunity for young people to experience the cultures of foreign countries.

Governor Bob presented a special award to the Sausalito Club for having passed the 20,000 per cent plateau level last year. They are presently over 22,000 per cent and are one of less than sixty clubs of the 24,000 clubs in the Rotary world who have reached this level.

The South San Francisco club celebrated the 16th anniversary of its two-building home for 210 low income seniors. The project is run by a board of directors made up of SSF Rotarians and the club has revitalized its involvement in the project. Meanwhile, later years saw the development of other such housing projects: Two in NOVARO projects in Novato, ROTARY MANOR in San Rafael and the new ROTARY HACIENDA in San Mateo. Governor Bob participated in the ground breaking of Rotary Hacienda on February 23. This \$5.5 million low rent senior housing project was begun with the raising of \$150,000 by the San Mateo club. It is expected to open in January, 1990.

After more than 75 years of meeting at the Palace Hotel, the San Francisco club moved to the Kensington Park Hotel at 450 Post Street.

On January 23 the Peninsula Rotary Council of San Mateo County sponsored a special luncheon at which district Rotarians and their guests hosted three Soviet economists. An excellent session, it showed how Rotary can contribute to world peace and understanding.

Among other resolutions adopted at the Council on Legislation in Singapore, one eliminated the requirement that membership in Rotary be limited to men. Another resolution adopted by the council was proposed by the Menlo Park and Redwood City clubs. It related to peaceful dispute resolution of conflict at all levels of human activity in the world. PDG Al Simonetti represented the district at the council.

San Carlos celebrated its 40th anniversary with a special gathering on January 6.

PDG Sid Berlin married a former Rotary Foundation scholar Peggy Atkins of Vancouver, B.C.

PDG Percy Bliss (1962-63), editor of the original Golden Book in 1965, died in San Jose.

Two separate District Assemblies were conducted by the new Districts. 513 met in Ukiah April 22 and 515 met at the Presidio in San Francisco April 29.

May 11-14 in Sacramento saw the last big District Conference. Walter Romp, PDG of District 660 was the President's Representative and Lt. General Dave Palmer, Supt. USMA, West Point, was a speaker. A fine district conference, it was well attended, combining fun and Rotary information and often involving emotional reference to the end of a special era of Rotary in the old District 513. It was a fitting climax to a great year of Rotary service led by Governor Bob Kane.



## JOHN M. VALLERGA

1989-90



During this year President of Rotary International Hugh Archer suggested that Rotarians "Enjoy Rotary" and a district theme of "Build Tomorrow" was added to that. District Governor Jack Vallergera, with the help of Elinor, was well equipped to promote both those ideas. This was of course the first year of the newly structured District 513. Clubs and members of the former district were divided approximately in half when Marin, San Francisco and San Mateo Counties became a new District 515 and the clubs in counties north of the Marin/Sonoma county line retained the identification of District 513. Jack's first job was to get the new district off to a good start and that he did.

Jack became a Rotarian in 1974 and served as president of the Santa Rosa East club in 1981-82. In 1986-87 he served as Area 7 Representative for DG Sid Berlin. A native of Eureka, he attended the University of California at Berkeley. He served as a teacher, coach and counselor in Santa Rosa from 1956 until 1987 when he retired. He has been active with the UC Alumni Association, Italian-American Club of Sonoma County, served as Deacon and Elder of the Presbyterian Church and was president of the Sonoma County Chapter of Phi Delta Kappa. After Rotary, Jack's hobby is fly fishing.

The annual Foundation Dinner was conducted in Eureka under the chairmanship of John Goff, John McCaddon and Rich de Lambert. It raised \$94,099.50 for the Rotary Foundation. Early in 1990 a Group Study Exchange was conducted with District 308 in Northern India. During this year the 25th anniversary of the GSE program was celebrated.

The Southwest Eureka club dedicated Evergreen Lodge with its six living suites for people undergoing long term medical treatment. This project no doubt helped them win the Presidential Citation Award for the year.

The Crescent City club awarded \$4000 in scholarships to Del Norte High School graduates. Petaluma held its annual Oktoberfest Family Day to benefit the PolioPlus campaign. Gualala had as its fund-raiser the Pickle Family Circus. The Santa Rosa club had its first annual Redwood Empire Auto Classic. Southwest Eureka celebrated 100% attendance during the month of August and conducted its annual Veteran's Day program featuring WWI. Sonoma Valley held its first Golf Busters Miniature Golf Tournament. The Napa club established a sister club relationship with the Rotary Club of Launceton City in District 983. Willits set up a window painting program for elementary school children. The Mad River club provided an operating table to be used in an isolated part of Northern Peru. A pancake breakfast sponsored by the Guerneville club benefited earthquake victims in Watsonville. The Arcata club sponsored a wrestling tournament for twenty schools in northern California and Southern Oregon. North Napa donated money to Interplast for reconstructive surgery for youngsters in developing nations. A Sebastopol project was a computer system for communicating with senior citizens who live alone. Calistoga helped to fund a bank of computers at Calistoga High School. Fort Bragg held their annual Magic Show to benefit their community service efforts. Napa, the oldest club in the district celebrated its 70th anniversary. Clearlake presented food baskets to the needy at Christmas. Lakeport received two special R.I. grants to support projects in Mexico. Crescent City conducted a community cleanup campaign. Healdsburg supported a community program of health and drug education in the city schools.

Rotarians were saddened by the news that two long-time secretaries of district clubs had been lost. They were Bill Scheider of the Petaluma club and Jim Durnford of Santa Rosa who represented many years of service to their clubs.

Governor Jack was pleased to announce that of the almost 25,000 clubs in the Rotary world, 1525 of them have reached the 10,000% plateau and 11 of those are in District 513. The district ranks 5th in unrestricted contributions among the 157 districts of USCB. It was announced that more than \$200 million had been contributed to PolioPlus.

A joint District 513/515 Interact Conference was held at Westminster Woods in Sonoma County. Awards were made for a variety of good projects by the clubs.

An exciting bit of Rotary history took place when a new club was established in Moscow making Russia the 168th country with Rotary.

Dave Dillon of Eureka was selected to be District Governor for the Rotary year 1991-92. The year ended with a net gain of 64 members in the district.



DGN John Blount and his committee conducted a well attended District Assembly at the Luther Burbank Center in Santa Rosa. The International Convention was held in Portland, Oregon.

A highly successful District Conference was conducted at the Red Lion in Sonoma County with 700 attending the affair. By a large margin the Southwest Eureka club under president Jim Gupton won the Presidential Citation Program as a result of its many fine projects.

It was universally agreed that the year was an outstanding one under the totally committed leadership of Governor Jack and his partner in Rotary service, Elinor. Though terminally ill, Elinor won the hearts of all who knew her as she supported the Rotary program throughout the year before she lost a long, brave fight with cancer on August 5, 1990.

## JOHN T. BLOUNT

1990-91

Certainly one of District 513's youngest governors at 40 and while maintaining a dental practice, John Blount used his youthful vigor to "Honor Rotary with Faith and Enthusiasm." That was the theme of Rotary International President Paulo V.C. Costa of Sao Paulo, Brazil and John indeed honored Rotary with his own natural enthusiasm. A hard-working Rotary Club of Sebastopol provided the assistance he needed to do the job.

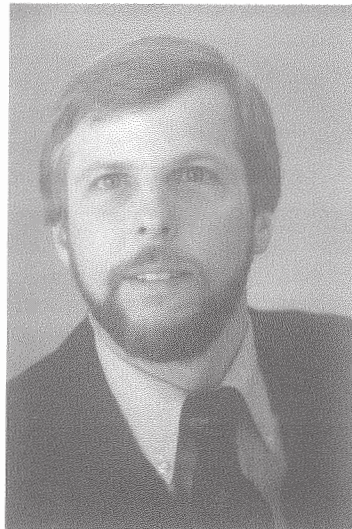

A Rotarian for 14 years, John was president of the Sebastopol club in the 1982-83 year. He and his wife Patti have a daughter Jenny. Born in Los Angeles, he graduated from Loma Linda University School of Dentistry and Loma Linda School of Arts and Sciences in 1975 with a D.D.S. degree and a B.A. in history. He served two terms on the Board of Directors of the Sebastopol Chamber of Commerce and was a director of the Redwood Empire Dental Society.

His District Newsletter was identified as the "Primer" - a reflection of his concern about literacy and education in the community. His District Assembly in Santa Rosa emphasized the subject and he pursued it further as he visited the district clubs.

The second district R.Y.L.A. camp was conducted at Westminster Woods on the Russian River with 61 talented high school leaders in attendance. Over 85% of the district clubs selected students to attend this six day retreat. Chairman Duane Blackwill of Petaluma and Camp Director Jim Underhill of West Santa Rosa received congratulations on the highly successful gathering.

In August Rotarians attended the funeral of Elinor Vallerger, wife of PDG Jack Vallerger.

The Windsor Club raised \$20,000 on its second annual Hot Air Balloon Classic. The Southwest club conducted their annual classic Mustang car raffle. Gualala made \$10,000 at its Labor Day Pickle Family Circus. The West Santa Rosa club netted over \$35,000 on a crab feed. Sebastopol's "Suitcase Night" provided \$15,000 for their service fund. The St. Helena club topped the fund raisers with a net of \$47,000 from their "Puttin' on the Ritz" dinner-raffle dance.

Total contributions to the Rotary Foundation for 1990-91 was \$183,135.56 with \$123,073.56 in unrestricted giving. The Foundation Dinner this year raised \$105,000 at north and south dinners in Eureka and Santa Rosa. Northern dinner chairman Pat Folkins and southern chairman Kent Seegmiller were congratulated for their efforts which saw 700 Rotarians in attendance.

Nine members of the Nishinomiya-Shukagawa club of Japan visited the North Napa club for a day and an evening of fellowship. The Guerneville club hosted visitors from the Puerto Vallarta club. Eureka and Southwest Eureka held their annual softball game. Clearlake Rotarians upgraded the sprinkler system at Austin Park. John Strong, immediate past president of the Petaluma Valley club spent a month in a remote area of Haiti to help with the installation of a water system for a hospital on a Rotary International "Rotary Volunteer" project. The Windsor club initiated a county-wide business-to-education network called "Winning With Education." Sebastopol continued its nationally recognized "Learn To Swim" program.

The Eureka club instituted a micro economics class at the city high school where members discussed various aspects of business. The Mad River club co-sponsored a History Day at local schools. The Petaluma club treated 109 worthy children to a Christmas Party. Ferndale Rotarians provided dinner for local senior citizens. Calistoga had their Bingo/Spaghetti feed operating. Healdsburg had a successful Crab Feed/Auction which netted \$9,000. Santa Rosa East covered the cost of remodeling the Salvation Army Silvercrest Retirement Home. Rohnert Park-Cotati produced their Fourth Annual Western Dance and Raffle. Arcata, Lakeport and Fort Bragg, conducted wrestling tournaments.

Healdsburg, Fort Bragg, Napa Sunrise and Windsor organized Interact Clubs such that 50% of the district clubs sponsor Interact Clubs. Interact members from around the district attended a ball game in Oakland and returned for a leadership conference in Sebastopol in May led by District Chairman Brian Langermann.

R.I. began the first year of a three year emphasis to "Preserve Planet Earth." District 513 planted over 10,000 trees in Humboldt County on November 3, 1990 with the assistance of Rotarians, spouses, Youth Exchange students and Interact members from clubs throughout the district.

District clubs conducted a Speech Contest with students from schools throughout the district. Chairman Jeff Boal helped develop and then administered the three tiered club and district competition. The topic further emphasized John's commitment to enlist Rotary business people in the support of education. The speech title was "What Business Can Do to Improve Education in California."

A Group Study Exchange was conducted with District 207 of Italy. The local group was led By Larry Francesconi of Fortuna. Four R.I. Foundation Scholarships were awarded.

DGN Dave Dillon had over 300 at his District Assembly in Fort Bragg. Fort Bragg, Mendocino and Gualala assisted in the event.

Youth Exchange student residents joined with outgoing students in an August orientation program; a November "Blue's Buster" Get-A-Way in Fort Bragg and spring conference in Occidental. Chairman Roger Coate of South Ukiah developed a program handbook for students, counselors and host families.

There were rave reviews of the District Conference at Sacramento. Featured speakers included R.I. President-Nominee Cliff Dochterman, California Assistant Superintendent of Schools Shirley Thornton, actor Billy Barty and Olympic basketball star Quinn Buckner. Attendees travelled through four decades of Rotary history with stage vignettes, videos and special events in "Back to the Future," the conference theme. The star of the weekend was R.I. President Representative Jim Young who played the part of Paul Harris in each of the four theatrical productions.

The International Convention was conducted in Mexico City.

Patti Blount, very much a part of the team, visited the district clubs with John and participated in all of the district functions.

There was a growth of 45 members in the district and the year's end saw that John's enthusiastic and committed leadership had resulted in stronger individual clubs and consequently a stronger district.



## DAVID M. DILLON

1991-92

David Dillon had spent many years of service to Rotary and District 513 before he was selected to be governor. As Chairman of the District Youth Exchange Committee, he established an award-winning program that continues in the district. He first joined Rotary in Arcata in 1967, moved to Eureka and became its president in 1976-77. He later served as club secretary for two years. Community activities included Director of Eureka Chamber of Commerce, President of Humboldt County Chamber of Commerce, Chairman of Humboldt State University Foundation, Chairman of United Way Fund, Chairman of St. Joseph Hospital Trustees and Chairman of Humboldt County 4-H Club Council.



A retired banker, Dave used his business experience, concern for details and endless energy to organize and direct his year. The district was renumbered to become 5130. R.I. President was Rajendra Saboo of India and his theme was "Look Beyond Yourself." Dave not only subscribed to it, but added his own; "Accept the Challenge-Rotary" as the district theme.

His wife, Carol, wrote a column for the newsletter, took part in all his club presentations and introduced a Friendship Quilt project to the district. When completed, she had a block from each of the 36 clubs plus a pillow block for the new club. Each block depicted a scene representative of the club or its projects or area. Raffle tickets were sold and more than \$7000 was given in grants to World Community Service projects.

Activities for the year began with a District Assembly in Fort Bragg and Mendocino which commanded a record turnout in spite of bad weather. A strong advocate of the Rotary Foundation, Dave honored the Paul Harris Fellows whenever it was appropriate. An innovative device—two ceramic bulls—"El Toro"—made their way through the district and the net, beyond the fellowship, was two special Paul Harris Fellow Awards given at the Foundation dinner.

The Foundation dinners—north and south—netted over \$116,000 and at one time the district was the top per capita contributor in the USCB. A Rotary Foundation Workshop—the first ever held in the district—was conducted in Willits in October led by PDG Jack Vallerga and PDG Larry Myers. All clubs were updated on the Foundation programs and the beneficiary program was announced by PDG Norm Lawrence.

The district newsletter, "Out of the Fog", was a colorful mailing to every Rotarian's home each month. It featured, over the course of the year, all the club presidents, area representatives and district committee chairs with photos.

Southwest Rotary and the district lost a very special member with the death of John McCaddon. John was serving as Governor Dave's aide and was a very dedicated and hard-working Rotarian.

Napa Sunrise and North Napa cooperated to stage the Great Napa Valley Duck race and raised some \$50,000 for their community. Sonoma Valley netted \$10,000 on an auction, Mad River and Arcata hosted a senior Thanksgiving dinner, Gualala did "Make a Circus", Old Town Eureka sponsored "Up With People", St. Helena made over \$50,000 for their community with a Winter Ball, Santa Rosa completed payment on a Salvation Army van, Mendocino made \$20,000 on an art auction, Sebastopol doubled that for a suitcase night, Calistoga gave computer equipment to their high school, Ukiah had a farmer's night and Santa Rosa Sunrise staged Westoberfest. Every club in the district completed a community service project including the nine clubs in Humboldt-Del Norte that purchased a special blood platelet machine for the Northern California Blood Bank.

PDG Art Agnew's dream came true as Rotary clubs dedicated a grove and bench in Golden Gate Park in honor of Homer Wood. R.I. President Saboo lead the delegation. In World Community activities, 14 clubs had projects in Mexico including Lakeport, Petaluma Valley, Ukiah, Calistoga, Southwest Eureka, Sebastopol, West Santa Rosa and Garberville who had club members travel to assist in a program. Other projects included books shipped by Rohnert Park/Cotati to Malaysia with Eureka sending to Belize. Fort Bragg donated funds for a bore well and bus stop in India while Lakeport helped with a school program in Chile. Mad River shipped medical equipment to Peru and Southwest Eureka sent a van to the cancer clinic in Mexico. Sebastopol began a one-year teacher exchange program with Mexico.

Crescent City started an Interact Club in September and by June it was named the outstanding club in the district. January 17 was

the occasion of the first provisional meeting of the new Arcata Sunrise Rotary sponsored by the Arcata Club. The efforts of Arcata President Jeff Redmond and provisional President Jim Hamby were finalized when 35 members were approved on February 17 with eleven coming from Arcata. On March 28 at Baywood Golf and Country Club, Charter night was held with PDG Charlie Strobe as the keynoter. This is the first new club in four years.

A Group Study Exchange team of women was selected to represent our district in Sweden, District 2400. The women were lead by Rotarian Patsy Barnes of West Santa Rosa. The incoming female team arrived in May and spent five weeks traveling around the district. Both teams met in Eureka for the District Conference and presented one of the finest GSE team programs ever in our district.

Duane Blackwill of Petaluma was selected as the District Governor Nominee for the year 1993-94. Del Raby, DGN, presented a District Assembly in Santa Rosa in April and at its conclusion we learned of a forceful earthquake in Humboldt County. Fortuna and Ferndale areas were hardest hit with over \$60 million in damages. A district earthquake fund was established and \$15,000 has been raised to assist.

The District Conference was held in Humboldt County June 4-7. A sports day with over 100 golfers participating began the affair with fishing, tennis, jogging and other sports also scheduled. The plenary sessions were held on the campus at Humboldt State with Oklahoma former Governor George Nigh, R.I. Representative Brian Knowles from Queensland, Australia and Dr. Don Ratley of Mt. Shasta headlining the activities. The dinner was held at the Adorni Center on Saturday night followed by a Sunday brunch at the Ingomar Club. More than 500 were registered.

The International Convention was held in Orlando, Florida, June 14-17 and was attended by about 50 from District 5130.

## DELBERT A. RABY

1992-1993

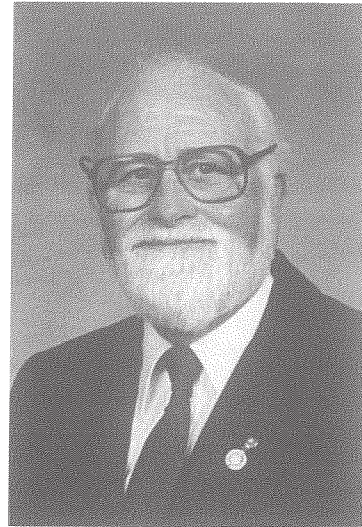

Del Raby was proposed for District Governor by the Rotary Club of Santa Rosa Sunrise. Chartered in 1986 this was a smaller, relatively young club but one whose members were full of Rotary enthusiasm. Del was involved in Rotary for 31 years and had served as president of the Mountain View club of District 517 in 1983-84. His work led him to live in several localities so he belonged to six Rotary clubs - Fontana, Alhambra, San Marino, Mountain View, Mendocino and Santa Rosa Sunrise. His career as a Boy Scout executive kept him committed to the welfare of youth. Other contributions to his community included the Santa Rosa Symphony Committee and service as docent at the California Museum of Art. He and his wife Harriett are both Paul Harris Fellows and share a hobby of weaving. Other hobbies included golf and archaeology.

Del's visits to district clubs was identified by his George Washington hat and a fascinating electronic device which demonstrated the meshing of Rotary wheels around the world.

The District Assembly to prepare club officers for the new year was held at the Luther Burbank complex in Santa Rosa April 24/25 1992 and was well attended. The keynote speaker was Dr. David Benson president of California State University Sonoma. The Assembly was chaired by Gary Doolittle, Santa Rosa Sunrise, and Buck Phillips, West Santa Rosa.

The President of Rotary International for the year was Clifford Dochterman of the North Stockton Club—well known to Rotarians of District 5130. The theme for Cliff's year was "Real Happiness is Helping Others", which Del communicated to district clubs. His monthly newsletter was called "The Rotary Sunrise"—"Only the Brightest of Thoughts". There were 2486 Rotarians in the district at the end of his year.

It was reported that again the RYLA camp at Westminster Woods in June was a success, 59 students from 31 district Rotary clubs participated in the gathering.

The Healdsburg club set up a program to teach young children about drugs and how they affect their bodies—"My body is Healthy". The program was featured in the Rotary publication "Your Community News" of February 1993. The Napa club had a BBQ fund raiser and awarded four \$500 checks for Teacher Recognition. Petaluma Valley sponsored a Sports Card Show. Mendocino held its annual Art Auction. North Napa featured a Cribbage Tournament. Sebastopol sponsored the Billy Barty Golf Tournament and Petaluma held its fall fund raiser "Autumn Food and Beer Fest". The Calistoga club provided an opportunity for students and business leaders to meet together. Clearlake developed a similar program to assist young people as they enter the work world. The Calistoga club decided to sponsor a Boy Scout troop.

A group study team from the district visited Germany's district 1810. The team was led by Fred Wulff of the Petaluma club. Group members represented the clubs in the Santa Rosa area. Santa Rosa, West Santa Rosa, Rohnert Park, Windsor and Clearlake. The Rotary Youth Exchange program, led by Roger Coate, was very active with 22 clubs sponsoring students. The year started with 15 students here representing 10 countries with 21 scheduled to start during the year.

In support of the World Community Service program the Ukiah club joined the South Ukiah club in sending equipment to a school for the deaf in India. West Santa Rosa helped to send various supplies to Radio for Peace in Costa Rica. The Eureka club shipped books and encyclopedias to children in Belize. Arcata worked with a club in India to provide equipment and staffing for a low cost health clinic. Mad River helped to provide medical supplies to combat a Peru cholera epidemic. Santa Rosa East sent dental equipment to San Jose Del Cabo Mexico. Santa Rosa East worked with the Jakarta, Indonesia club to help provide equipment and materials for cataract surgery. Petaluma and Petaluma Valley worked with a club in Zihuatanejo, Mexico to equip a fire house.

The four Santa Rosa clubs in an organization called the Santa Rosa Quad Club worked to reduce truancy in Santa Rosa schools. The Second District 5130 speech contest was conducted.

Clubs were encouraged to contribute to the support of disaster relief programs after hurricane Andrew and Iniki struck Florida and Hawaii.



The Eureka and Santa Rosa clubs joined in supporting youth athletics by once more conducting high school All-star Basketball games. There were games between the club members, senior boys and senior girls. The Lakeport club sponsored its annual Easter egg hunt for which 150 dozen eggs were distributed.

Two outstanding Rotary/Foundation Dinners were conducted in November—one in Eureka at the Eureka Inn and one in Napa at the Silverado Country Club. Jim Gupton of the Southwest Eureka club and Jeff Redmond of Arcata chaired the northern meeting while Steve Bardessono of Napa and Herk Swaney of Santa Rosa East directed the southern gathering. 600 people attended the two dinners which raised \$104,663 for the Foundation.

It was reported that Interact was alive and well in the district. Five new clubs have been chartered within the last three years. This year saw the 30th birthday of Interact with 7500 clubs in 101 countries with over 165,000 young people.

It was reported that the last case of paralytic polio in the Western Hemisphere was reported in Junin, Peru on August 23, 1991—a milestone in the history of Polioplus.

John Strong of the Rotary Club of Petaluma Valley was selected as the District Governor Designate for the year 1994-95.

District Governor Duane Blackwill's District Assembly was held April 17 at Mendocino College in Ukiah. Co-chairmen were Borue O'Brien of Petaluma and Joe Madrigal of Ukiah. 275 Rotarians and guests from 35 clubs attended the meeting.

The District Conference was conducted May 14-16 at the Red Lion Hotel in Rohnert Park. It was chaired by Kent Seegmiller of the Santa Rosa Sunrise club and Larry Bello of the Santa Rosa club. The R.I. President's Special Representative was Basil Marhofer of Kansas. A feature of the conference was a "Brag-O-Ree" area where clubs had the opportunity to show off displays of their various service projects. Finals of the student speech contest were held during the conference.

The International Convention was held in Melbourne, Australia.

As his year ended Del was pleased to note that service to youth was prominent in the district as 19 clubs sponsored Interact Clubs; 21 were involved in youth athletics; 22 hosted youth exchange students; 25 were involved in national youth programs; 26 participated in the speech contest; 29 are sending students to RYLA; 30 conducted vocational events for youth; 36 presented scholarships; 37 have projects involving schools. Beyond those there were a wide variety of other community and international service projects that identified the year as an outstanding year of Rotary service.

## DUANE BLACKWILL

1993-1994

Duane Blackwill, a Rotarian since 1975, was president of the Rotary Club of Petaluma in 1987-88. During those years he was active in youth projects such as exchange students and Rotary Foundation Scholars. He served as chairman of the Rotary Youth Leadership Awards committee for the district from 1989-92 and was District governor John Blount's Area Representative for southern Sonoma County during the year 1990-91. He and his wife Metha are Paul Harris Fellows.

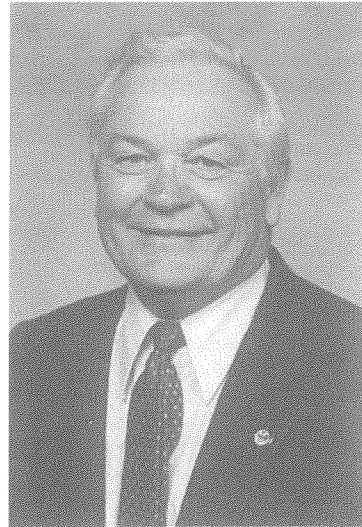

Duane graduated from the University of the Pacific and received a Masters Degree from California State University in Fresno. He taught, coached and counseled high school and college students, retiring in 1992. Having lost his first wife to illness, he and Metha were newlyweds at the time he took office. Duane was quickly recognized throughout the district for his energy and special good humor.

The president of Rotary International was Robert Barth of Aarau, Switzerland. The president's theme for the year was: "Believe In What You Do—Do What You Believe In". To this Duane added his own theme: "Commitment: The Key to Success", His newsletter was titled "Chicken Scratches"—in recognition of Petaluma's reputation as the egg producing capitol of the world.

Duane prepared his club leaders for the year ahead at the District Assembly on April 17 at Mendocino College in Ukiah. Another highly successful RYLA camp was conducted at Westminster Woods. The annual Foundation Assembly organized by Jack Vallerga was held in Willits on July 24 with 24 clubs represented.

Once again two Rotary Foundation dinners were conducted—the southern meeting at Silverado in Napa and the northern a western barbecue dinner at the fairgrounds in Ferndale with the Ferndale club preparing the meal. The southern dinner was chaired by Steve Bardessono and Herk Swaney while the northern one was chaired by Jim Gupton and Jeff Redmond. The two dinners raised \$114,000 for the Foundation.

A first in Rotary history was established when a woman member of a Michigan club was nominated to be Governor of District 6380 during 1994-95.

World Community Service projects included: Santa Rosa—transporting hospital equipment to Mexico; Rohnert Park—Cotati—books to Malaysia; Petaluma Valley—purchase of an ambulance in India; Windsor—hospital equipment to Costa Rica; Middletown—supplies for the hearing impaired in Costa Rica; Ukiah—air conditioners to a school in San Filipe, Mexico; Mad River provided 130 boxes of pharmaceutical, surgical and other medical supplies to the isolated town of Bagua, Peru.

The Windsor club held its fifth annual Hot Air Balloon Classic over the Fourth of July weekend. Santa Rosa East conducted a Concour d'Elegance on September 5—beautiful old cars. Calistoga published a 32-page club history. Santa Rosa held its 10th annual symposium on employment of people with disabilities. The Eureka and Southwest Eureka clubs were active in supplying equipment for a new blood bank. The three Napa clubs hosted the third annual Great Napa Valley Duck Race, the over \$65,000 went to the local schools. In addition they raised \$15,000 for the American Cancer Society. The Napa Sunrise club donated funds raised in their Rotary Run to the Literacy Program. Lakeport completed a retaining wall at the high school athletics field. Mendocino held its annual Art Auction. Petaluma Valley held a yard sale. The Willits club supported the Drug Abuse Prevention program. Fort Bragg changed the format of its "Career Development" program to a different approach called "Job Shadowing". Clearlake provided an identification card that teenagers are encouraged to carry. Eureka continued its vocational class at the high school. Calistoga joined with the Soroptomist club to sponsor the second grand display of antique autos and aircraft. The Napa club proudly announced that they have 124 Paul Harris Fellows. Petaluma Valley planned a Christmas Tree Giving program—gifts for convalescent home residents. Petaluma raised \$25,000 in a crab feed and gave to the schools and the Boys and Girls Club.

The Eureka club celebrated its 70th anniversary with a special program. Lakeport, South Ukiah and Ukiah sponsored the United Way Loaned Executive program. Fortuna communicated with a sister club in Japan.

Other fund raisers were West Santa Rosa's crab feed and Santa Rosa East's Western Night. Southwest Eureka—donated \$5,000 to the Literacy Program and conducted a kite festival. Eureka gave \$6,500 to the high school band for new uniforms and contributed to the

Humboldt Literacy project. Mad River painted the Senior Center and planned an effort to purchase a scoreboard for the Active Recreation Center. Garberville-Super School Fund Raiser—they contributed \$10,000 to the Humboldt Schools Foundation. Arcata Sunrise donated \$1,000 to the Arcata Educational Foundation. Middletown purchased traffic signs for elementary schools. Arcata staged a 50's style car show. Fortuna purchased a senior related "Are You O.K.?" program.

The district participated with other northern California districts in a special Presidential Dinner for Robert Barth and his wife Gerty at the San Jose Red Lion Hotel, January 4.

The 1994 Group Study Exchange team, led by West Santa Rosa Rotarian Mary Fahra, traveled to Honduras, Costa Rica, Panama and El Salvador in February. Our Central American team was here in April and May in time for the District Conference. There were 32 applicants for the experience from which the team was chosen. The Central American Team for a number of reasons failed to visit our District in the Spring, 1994.

The youth exchange program chaired by Roger Coate continued to thrive as 21 clubs participated this year. Interact Seminars were conducted—one at McKinleyville in the north with 25 attending and another at Petaluma in the south with 35. The Interact Leadership Conference was held at Westminster Woods with 17 schools represented.

Cameron Reeves of Lakeport club was selected to be District Governor for the year 1995-96.

The District Conference was held May 13-15 at the Red Lion in Rohnert Park. The R.I. President's Special Representative was Lynn Hammond of Loveland, Colorado. Other speakers included ex-49er Bob St. Clair and Dr. Joe Serra. The program included a Rotary Challenge contest among the clubs about details of Rotary Information and also the finals of the speech contest.

At the end of the year there were 2468 Rotarians in the district. Duane and Metha could be proud of the accomplishments of the year and the service which they represented.



## JOHN STRONG

1994-1995

John Strong became a Rotarian in 1984 and brought to the Petaluma Valley club an even stronger commitment to service in community and around the world. His numerous efforts include major projects in Mexico, India, Haiti and Manila, with personal visits to remote areas of these countries. John personally installed a water collection system at a hospital in Haiti. He received the District Hall of Fame Award in 1991.

He was born in Whitby, Yorkshire, England and grew up in Liverpool. Trained as a metal worker, he emigrated to the United States and continued that career. His specialty is copper work.

John was President of the Petaluma Valley club in 1989-90, and Area Representative in 1991-92 and District World Community Service Chairman in 1992-93.

The 1994-95 President of Rotary International was William Huntley of Alford and Mablethorpe, Lincolnshire, England. His theme was "Be a Friend". During the year Rotarians had an opportunity to hear him speak at a special dinner in San Jose. A large number of District 5130 Rotarians, spouses and friends attended the affair. The Director representing this zone was Grant Wilkins of Inglewood, Colorado.

John conducted a District Assembly at Mendocino College in Ukiah on April 16. The program prepared leaders of the district clubs for the upcoming year. Ralph Williams was Chairman of the District Assembly. The District Foundation Seminar was held at Willits High School on July 30. Through his monthly newsletter he directed clubs to "Communicate-Educate-Effectuate-Demonstrate". This theme was extended to provide for a traditional high school speech contest and a new visual arts contest. He declared that one of his main objectives was to communicate and educate Rotary members and other community members about Rotary.

John demonstrated his strong commitment to international service when he delivered an ambulance to a remote village in India. The vehicle will serve as a mobile clinic for two doctors who provide care to a scattered population of 15,000. The project was funded by support of local clubs and matching grants from the district and Rotary International.

Chairman Ralph Williams directed the Fifth Annual RYLA Camp at Westminster Woods in Occidental on June 12-17. Twenty-nine district clubs sponsored sixty students at the meeting.

The Windsor club welcomed visitors to its sixth annual Sonoma County Hot Air Balloon Classic over the 4th of July weekend. The Fort Bragg club made \$2700 at a yard sale to benefit Hospice. The Sonoma Valley club reported that diabetic children in Kiev will receive assistance through a matching grant of \$20,000. The Ferndale club granted several scholarships. Santa Rosa Sunrise raised \$12,000 from a golf tournament. The Mendocino club took a leadership role in raising \$519,000 for a new community firehouse.

The Ukiah club netted over \$5,000 from a golf tournament. By way of Foundation matching funds, the Santa Rosa club saw their \$4,000 grow to \$8,000 which was used to outfit a school and clinic for troubled children in Ciudad de Mexico. Healdsburg conducted a book drive for the benefit of Granada. The Southwest Eureka club raised \$10,000 in their Auction By the Bay. Napa Sunrise ran a Bingo game at the Fair. Mad River continued their program of donating to a program that makes awards to students "Doing Something Good". Old Town Eureka sponsored a performance of "Up With People". Sonoma Valley supported a softball tournament. Windsor formed a Sister Club relationship with a club in Thailand. Santa Rosa Sunrise raised over \$20,000 from a raffle fund raiser. Ukiah held a very successful boys Soccer Tournament. West Santa Rosa joined with their sister club in Colon, Costa Rica to provide desks for a school. Ukiah held a Farmer's Recognition Night dinner and 65 farmers attended.

The Santa Rosa club held their Annual Symposium on the employment of People With Disabilities. For this effort they were selected to receive the prestigious Distinguished Service Award from the State of California. Santa Rosa East had a student exchange with the Kamo Rotary Club of Japan.

Clubs were asked to recognize the 50th anniversary of the United Nations. Among the participants in this historic event in San Francisco there were 49 Rotarians.

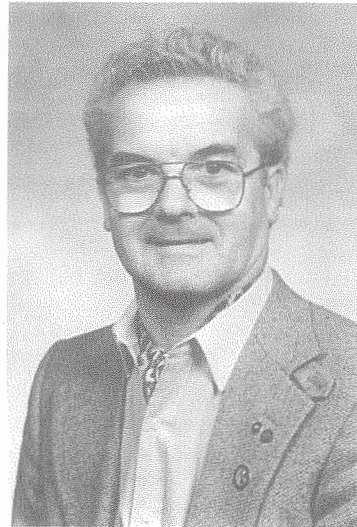

Two Interact Leadership Conferences were held during the year—one in September in Petaluma and another one at Westminster Woods in the spring, on March 24th and 25th 1995, in conjunction with the Youth Exchange Students. 90 Interactors attended and 42 exchange students.

On February 23rd, Governor John delivered a charter to the new Fortuna Sunrise Club. Sponsored by the Rotary Club of Fortuna, it had 40 Charter members.

Bob Barwick, Past District Governor (1968-69) and past President of the Napa Club, was recognized for his generous \$10,000 gift to the Rotary Foundation.

A Group Study Exchange Team was sent to Brazil in April. The team was led by Bill Fisher of West Santa Rosa. The group included team members sponsored by West Santa Rosa, Santa Rosa Sunrise, South Ukiah and Fortuna. Ambassadorial Scholarships were awarded to students from Ukiah (going to Spain) and Sebastopol (going to Costa Rica).

Representatives of 27 clubs attended the District Foundation Seminar which was co-chaired by Wally Lowry of Santa Rosa and Jerry Besses of Petaluma. At that meeting updated Foundation information was provided to the clubs.

Two Foundation Dinners were conducted—the northern at Ferndale November 5 and the southern one at Napa November 19. A total of \$125,149 was raised from the two dinners. The northern gathering featured Past R.I. President Ed Cadman as speaker and included a surprise recognition of Charlie Strobe with a “This is Your Life” video.

Past District Governor George Starbird (1965-66) died.

The Sonoma Valley club, assisted by a special R.I. grant, sent educational material and medical supplies for children in Kiev, Ukraine. Both Ferndale and Clearlake continued their World Community Service projects in Mexico.

The District Conference was held May 19-21 at Konocti Harbor Inn on Clear Lake—a return to the site of many previous conferences. Granville Stark made certain that it was an outstanding gathering. Consistent with the special commitment that Governor John Strong clearly felt toward World Community Service, that area of International Service was emphasized during the program. Special guests from other countries added a special international flavor to the meeting. The R.I. President’s Special Representative to the conference was Samuel L. Greene, PDG from District 5240.

The International Convention was held in Nice, France and saw a good representation of District 5130 Rotarian families in attendance.

At year’s end Governor John could be proud of a year that focussed on World Community Service, with more clubs than ever involved in some form of International Service. The world can be said to be a better place for this year of concerned effort.

## CAMERON L. (CAM) REEVES

1995-1996

Cam Reeves, an attorney with the classification Municipal Law, has served as the County Counsel for Lake County since 1981, the year he joined the Lakeport Club. Just as he was active in community and professional affairs, he immediately became active in Rotary, serving as club president in 1989-90, and chair of the district awards committee and member of other district committees the following three years.

Cam and his wife Sharon, a registered nurse, have four children and enjoy tennis, skiing and traveling. They both continued their professions while serving the district as governor and "first" partner.

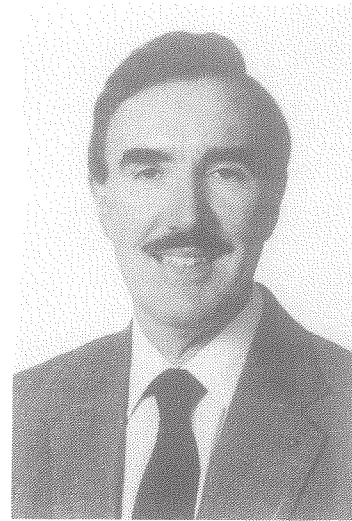

During this year, the President of R.I. was Herb Brown whose commitment to Rotary was reflected in his theme "Act with Integrity, Serve with Love and Work for Peace" as well as his past leadership in the Polio Plus effort as chair of the USA fund drive in the 1980's when he was also the guest speaker at our district's first Foundation Dinner North in 1986. His wife and "first" lady Diane influenced him to also emphasize family values during the year.

Cam added his own theme "Rotary is Community" as he challenged clubs to make Rotary better in our communities by: strengthening our youth programs and extend them to "at risk" youth, increasing membership and retention to reverse the decline of past years, develop new leadership for clubs and the district, initiating joint club programs, more Rotary partner involvement and strengthening our support of the Rotary Foundation programs.

Cam published an outstanding newsletter each month, the "Rotary Community Forum" which was mailed to every district Rotarian. It was edited by Carl Webb of Clearlake and featured columns on: his governor's message "Cam's Brief", Focus on Youth, Club News, joint club activities "The Community of Rotary in Action" and a popular one by Sharon entitled "Partner's Notebook" which was folksy and contained regular recognition of Rotary partners around the district.

Cam set the tone for the year in the preceding April with a highly successful Assembly in Ukiah at Mendocino College chaired by Tom Lincoln of Lakeport and Bill Cornelison of Clearlake which was attended by more than 350 Rotarians and partners. A unique addition to the program was an Open Forum where current Rotary issues were discussed as well as the outstanding concert at the Assembly dinner by the Kelseyville H.S. Jazz Band.

Almost 100 Rotarians attended the Foundation Seminar in September at Willits H.S. chaired by Steve Bardessono of Napa which also included two additional seminars: a club secretaries' workshop and a session on membership development.

Cam's club visits were highlighted by his presentation of the "Quiet Rotarian Award" to three members of each club and a special-made pin to recognize members who consistently worked hard but did not seek recognition, their names being published in his newsletter. In addition, he presented all of his presidents with a special Rotary Hawaiian shirt in promoting their attendance at the Conference. Sharon also promoted partner involvement in the child immunization programs in each area of the district and developed a partner's fundraiser for the Foundation.

In November, two highly successful Foundation Dinners were held with guest speakers Richard King, PRID at the North dinner and James Hawkins, PDG of District 5240 at the South dinner. Then, in early January, the pronounced influence of District 5130 was evident, first in the Rotary Rose Parade float which featured Charles Schulz of Santa Rosa and his "Peanuts" characters with a theme of "Lending a Helping Hand" and Cam having the honor of hosting and introducing R.I. President Herb Brown at the annual nine district dinner in San Jose for the R.I. President.

As the year progressed, outstanding accomplishments on Cam's goals and challenges were noted and recognized:



MEMBERSHIP/EXTENSION - 2 new clubs were chartered in this year: Del Norte Sunrise, led by governor's special representative Bell Shriver of Crescent City, on August 21; and Kelseyville Sunrise, led by governor's special representative Bill Burnes of Lakeport, on May 8. In addition, a provisional club was started in American Canyon led by governor's special representative Bob Barwick, PDG of Napa and Cam obtained the commitment of the Sebastopol club to begin discussion of the formation of a new sunrise club in Sebastopol. The membership of the district rose to its highest level of 2526 members this year with the addition of 120 net new members, the largest increase in district history and placing the district in the top 12 districts in the USA for the year.

INTERNATIONAL PROJECTS - 21 clubs had matching grant world community service projects this year, the most significant one was a project by the Mad River club chaired by Dennis Ryan in a northern California drive that collected 100 wheelchairs and over 300 walkers, crutches and prosthetic devices to add to the "Love without Borders" project of humanitarian aid for the maimed and injured children of the Bosnian civil war; the Lakeport club also delivered an ambulance to its sister club in Loreto, Mexico.

JOINT CLUB PROJECTS - the Redwood regional clubs of Del Norte/Humboldt counties organized a disaster relief organization; the six clubs of Lake and eastern Mendocino county organized a project in rural Mexico; and the SOS program of the quad clubs of Santa Rosa (Main, East, West & Sunrise) gained worldwide recognition with a feature article on this outstanding program, facilitated by Cam, in the Rotarian magazine.

ROTARY FOUNDATION - contributions to the Rotary Foundation this year totaled \$164,490 which exceeded Cam's goal; on Valentine's Day, Cam honored Glyndon (Sign) Smith of Eureka in his club with a crystal dove for his major gift of \$10,000 to the Foundation; the district donated a full Ambassadorial Scholarship to District 3850 in the Philippines and selected a student from there who studied here in the 97-98 year; sent a GSE team to District 3810 in the Philippines led by team leader Chris Parr of Windsor and received an outstanding and talented team from Manila; oriented three out-bound scholars and selected three more for the Ambassadorial Scholar program; and donated \$5000 to District 5010 in Alaska for its Russia expansion projects.

In April, Sonoma Valley celebrated its 50th anniversary and in early May there was a sister district (District 5150) reunion with a "Rotary Family Day" at a Sonoma Crushers baseball game and a BBQ which was well attended by Rotary families from our two districts.

The year was capped off by a superb Conference at Konocti Harbor Resort in Lake County, May 16-19 with the theme "Flying High with Rotary" chaired by Bill Brunetti of Lakeport and Rich Thomas of Middletown and while the weather was stormy forcing the cancellation of the scheduled air show over Clear Lake to kick-off the conference on Friday, all activities were attended by record numbers with 550 attendees. Over 50 golfers played 18 holes in driving rain on Thursday at Hidden Valley Golf Club, ABC science correspondent Jim Slade was the opening speaker with a dramatic presentation of "Apollo and Beyond" along with a repeat performance by the Kelseyville H.S. Jazz Band, Friday night was 50's theme with the great "Rock and Roll Revue" and dancing with the popular Johnny Baron and The Bel Airies, the Saturday speaker was the R.I. President's Personal Representative, PDG Gary Stevens from District 5010 in Alaska with their experiences in Rotary expansion into Russia along with an outstanding concert by the Lower Lake H.S. Jazz Choir followed by the Communications contest finals and a great Youth Exchange program, "Leadership Night" on Saturday night with a formal presentation of all club presidents partners escorting their presidents-elect and partners followed by an evening of superb swing music and dancing with the Bay Area Big Band, then on Sunday two great presentations to end on a high note with Dr. Jon Andrus, the medical officer in charge of the Polio eradication programs in Asia who flew in from New Delhi, India to give us an update on the National Immunization Days there followed by the stirring keynote speaker Lee Bussard presenting his "More Alike Than Different" to close the Conference.

## LARRY KAVANAUGH

1996-1997

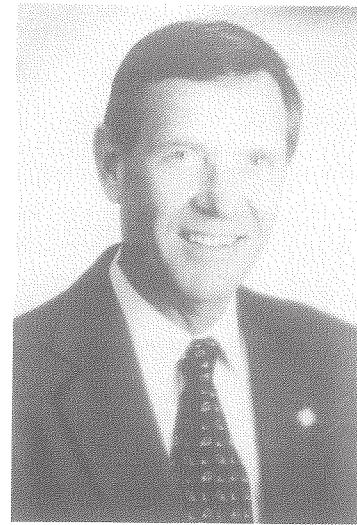

Larry Kavanaugh brought more than 30 years of experience in higher education to his task as District Governor in 1996-97. Ably supported by the Rotary Club of Southwest Eureka, Larry used his writing and communication skills to stimulate the 40 clubs in the District to "Build the Future with Action and Vision" the theme of Luis Vicente Giay of Argentina, R.I. President. Larry's theme was "Fully Realize Rotary," and he encouraged every Rotarian to "realize" Rotary by: 1) learning more about its programs and 2) by personally doing more to become more of a Rotarian. Larry used the written word and electronic communication to sell his program and the district responded with a number of new initiatives and the highest annual fund giving in the history of District 5130. Under Larry's leadership, the District:

Exceeded the DG's goal of \$65 per Rotarian in annual giving to the Rotary Foundation. The year end total was \$76 per capita, which set a new record for donations to the annual fund of the Rotary Foundation at \$174,565. North Napa led the per capita giving with \$202 per Rotarian. Crescent City hit \$171 and Old Town Eureka achieved \$161 per capita.

Inaugurated the "Festival of Brotherhood" with District 4150 of Central Mexico, over 50 Rotarians and their guests attended the two-day "festival" in February, 1997. This meeting of Rotary leaders from the two districts resulted in eight applications for World Community Service projects, utilizing club and district funds from both sides of the border as well as SHARE funds and international funds.

Chartered the Sebastopol Sunrise club with 30 members and with Bruce Campbell as the first club president. The club was chartered May 26, 1997, 72 years exactly after the Sebastopol club was chartered in 1925. In other club developments: The Rotary Club of West Santa Rosa changed its name to "The Rotary Club of Santa Rosa West." Two clubs, South Ukiah and Middletown experimented with changing their meeting time to mornings instead of noontime.

Held a very successful district conference in Humboldt County that drew 475 registrants, representing every club in the district. The keynote speaker was aviation record-breaker Chuck Yeager and the R.I. Rep was Director-elect Carl S. Rosenbaum of Little Rock, Arkansas.

Inaugurated "Project Share Life" program in the district. PSL is a program to register prospective bone marrow donors. Nyle Henderson was the point person in getting district clubs involved. Through his efforts more than 100 Rotarians have been scheduled to be tested as potential donors. The program was set up in cooperation with the Leukemia Society. More than \$4,000 was donated by Rotarians to support the costs of doing the blood tests.

Launched the Permanent Fund campaign to build the endowment of the Rotary Foundation. PDG Cam Reeves chaired the committee. The District made a dramatic improvement in beneficiaries to the permanent fund under the leadership of Ralph Williams. Benefactor in the district increased from 43 to 69, an increase of 60%

Inaugurated the first District 5130 web page on the internet in conjunction with North Coast Network and Larry Goldberg. The new page contained information about district officers and district projects. A special section described "Project Share Life."

Represented the District at the International Convention of Rotary in Glasgow, Scotland. DG Larry hosted a reception in Glasgow for District 5130 attendees and their Rotarian friends. Rotarians attending the reception represented five different continents.

Hosted an enthusiastic Group Study Exchange team from District 1410 in Southern Finland and Aland, an autonomous province between Finland and Sweden. The district sent a team, led by Jerry Medlin to Finland and Aland. Larry also arranged a Group Study Exchange with District 1910 in Austria for the 1997-98 year.

Participated in the selection of three Ambassadorial Scholars for the 1997-98 year and welcomed an Ambassadorial scholar from the Philippines who will be studying on a scholarship donated by the district through the efforts of PDG Del Raby.

Received its first Carl P. Miller Discovery grant, awarded to and carried out by the Rohnert Park-Cotati club. Preliminary planning for a 3-H grant in Peru and a 3-H planning grant application to support health care and health education in Nicaragua were also actively supported by DG Larry.

Club projects of large scale and special note during the 1996-97 year included:

- 1) The completion of a wing of the technical high school in Napa by the Rotary Club of Napa.
- 2) The donation and delivery of a school bus and a garbage truck to the San Jose del Cabo area of Mexico by the Rotary Club of Napa Sunrise.
- 3) The dedication of the playfields at Steel Lane Elementary School by the Rotary Club of Santa Rosa Sunrise.
- 4) Raising the funds and undertaking the reconstruction of the community center by the Rotary Club of Sebastopol.
- 5) Launching the campaign and being the lead organization for the construction of a Law Enforcement Building in McKinleyville by the Rotary Club of Mad River.

Youth programs continued strong in the district during 1996-97 with record attendance at both the RYLA camp in June and the Interact Leadership camp in March. A spirited Youth Exchange program continued in the district with 22 incoming students visiting from other countries and 19 young people from our district spending a year abroad.

The award-winning SOS (Support our Students) anti-truancy counseling program continued to grow in scope and success during 1996-97. Sponsored by the four Rotary Clubs in the Santa Rosa area in conjunction with the Sonoma State University, the program was "cloned" to the Petaluma area under the auspices of the Rotary Club of Petaluma Valley and The Rotary Club of Petaluma.

The first Rotaract Club, with 40 members, was formed at Humboldt State University, sponsored by the Rotary Club of Arcata and President Lane DeVries.

The Rotary Club of Santa Rosa, the largest and the second oldest club in the district, celebrated its 75th anniversary with a year-long series of activities and projects, under President Norm Owen. The year was highlighted by an elegant celebration dinner in Santa Rosa October 25. An excellent history of the club, "United in Service," was published to mark this significant anniversary of the club.

The Rotary Club of St. Helena continued to show the way in fundraising. The club raised more than \$110,000 in a single evening at the "Caribbean Nights" soiree on March 8. The proceeds benefit the St. Helena Rotary Foundation which supports the local Boys and Girls Club and the St. Helena Public Schools Foundation.



## LARRY BELLO

1997-1998

Born and raised in New York City, Larry attended Marist College and the University of Colorado. Following a four year tour in the U.S. Air Force Larry was employed by IBM for 31 years where he held a number of management and executive positions in the field and was promoted to Manager of IBM's Plant in Colorado and thereafter as Manager of the San Jose Plant in California. Following retirement in June 1986, Larry and his wife, Nancy, took up residence in Santa Rosa, California where he became President of the Oakmont Golf Club and a member of the Rotary Club of Santa Rosa. He was named Rotarian of the year of his club in 1989-90 and became Club President the next year. Later he was elected Governor of Rotary International's District 5130. Larry, his wife Nancy and his Granddaughter are all Paul Harris Fellows.

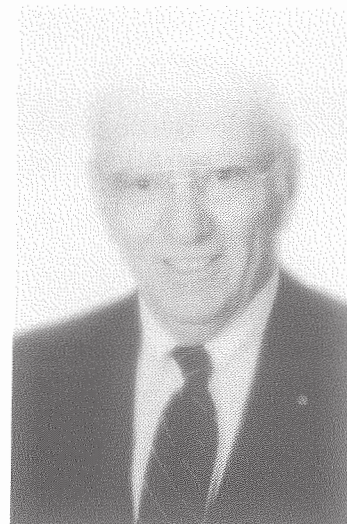

In addition to serving on numerous committees as a member of the Santa Rosa Rotary Club, Larry was very active in the Santa Rosa community. He was a member of the Outreach Committee at Santa Rosa Memorial Hospital, a Director of the United Way, Chairman of the Finance Committee at his church, and served on numerous other Boards and Committees. He and his wife, Nancy, have three daughters, a son, and ten grandchildren.

Larry established clear and firm goals for the 41 Clubs in the District. The four most pronounced were in the Four Avenues of Service. In his guidance for Community Service he asked each club to participate in the Immunization USA project; participate in the Literacy for Youth program; raise the awareness of Rotary within the community; adopt a project to help solve the problems of poverty and hunger in the community; and for every club to participate in the (RYLA) program. (See below for results).

In Vocational Service Larry requested that each Club conduct briefings on the Four Way Test, be conscious of the National Barrier Awareness Program, as well as the subject of employing People with Disabilities. The Santa Rosa Club expounded on Barrier Awareness and People with Disabilities with professional speakers.

International Service was of prime importance to Larry, particularly on the subjects of Scholarships, Youth Exchange, Group Study Exchange, and World Community Service. The World Community project received a \$17,000 planning grant for a program in Peru, Ecuador, and Nicaragua.

In addition to the above, Larry established plans and objectives for the clubs to follow in the administration of clubs. He also set forth guidelines for each club to follow in the general conduct of club affairs.

Larry conducted his District Assembly at Mendocino College, Ukiah in April 1997. Following the Friday night festivities, Saturday's agenda included Keynote Speaker Keith Woods who gave an inspiring motivational speech to the incoming club presidents and their staff. Several "break-out" sessions were held throughout the day covering appropriate subjects, as well as a presentation on the "Spouses in Rotary" There were 291 Rotarians and their partners in attendance at this highly successful District Assembly.

In support of Rotary Foundation, Larry asked each club to achieve a level of at least \$70 per club member. This was exceeded by \$9.00 to \$79 per capita. Larry was also intent on every Rotarian becoming a Sustaining Member or a Paul Harris Fellow. As a result, Sustaining Memberships increased by 104 to 2,086 and Paul Harris Fellows increased by 237 to 2,578. His stated goal was to attain a level of 10% in the Permanent Fund program. The contributions made for the Permanent Fund were \$7,200 and 28 Benefactors. Larry held the Rotary Foundation Annual Banquet for the south at the Flamingo Hotel in Santa Rosa. The Banquet for the north was held at the Eureka Inn. District Rotarians contributed a total of \$199,377 to the Rotary Foundation - the highest ever.

Rotary International's program on Ambassadorial Scholarships was supported by most of the District clubs. The District committee interviewed 11 students, recommending three for study in foreign countries. Rotary International approved all three.

The Group Study Exchange visit from May 2nd to June 6, 1998 was very successful. The visiting Team was from District 1910 in Austria, with representatives from Hungary and Croatia. Team Leader, Dr. Heinz-Michael Muller and the four Exchange members were escorted far and wide throughout our District, visiting agriculture, industrial and cultural sites, as well as business and professional offices in our region. During the time of their visit we were privileged to send five representatives from our District to Austria to learn more about their country. Mike Ferguson was the team Leader of our group.

The Youth Exchange Program was quite successful. A record was set as our District entertained 25 teenagers from foreign shores. An Orientation meeting was held at Westminster Woods for both incoming students and our outgoing students. The Group performed beautifully at the District Conference.

The Interact Program saw an increase in the number of Interact Clubs to 441 of which 13 were in Junior High Schools. Clubs reported that there were a multitude of community projects accomplished by these youngsters. One of the highlights was the selection of six where they observed government at work.

The World Community Service Program was very active during Larry's year. R.I. approved Matching Funds for 10 projects sponsored by 11 clubs for assistance to an equal number of foreign countries.

The Rotary Youth Leadership Awards (RYLA) camp was held June 15 - 20, 1998 at Westminster Woods in Occidental. There were 70 students in attendance which included 31 boys and 39 girls. In summary the 1998 RYLA camp was very successful. PDG Duane Blackwill was presented a plaque for his RYLA work over the years, placing him in the District Hall of Fame.

During Larry's term he appointed Rotarian Don Ahlborn the Chair of the Rotaplast Committee. Don and his Committee helped organize a team of 30 medical and Rotarian volunteers to perform surgery on Venezuelan children with facial deformities. The entire cost was supported by donations from Rotarians and other individuals. The team performed 126 procedures as they successfully operated on 106 children at no cost to the families. The Santa Rosa Rotary Club was awarded a plaque for their humanitarian efforts in supporting this project.

A new Rotary Club was sponsored by the Sebastopol Club during Larry's year, designated the Sebastopol Sunrise Club. Louis G. Desol from the Rotary Club of Ukiah was elected District Governor for the year 1998-99.

Larry held his Annual District Conference on May 29-31 at the Doubletree Hotel in Rohnert Park, California where he presented an agenda of accomplishments and events that was informative and entertaining. The conferees were welcomed by the Mayor of Rohnert Park. The Keynote speaker was Rick King, a Trustee of the Rotary Foundation. Rotary International President Glen Kinross's personal representative, Keith Dindinger, spoke on the President's theme, "Show Rotary Cares". Saturday's speaker was PDG of District 676 and humorist Charles Laine. That afternoon we were privileged to hear PDG Joe Serra. His subject was "From Crawler to Walker-To Polio Free World". Plenary Sessions Covered the Four Avenues of Service and related subjects. As Larry said, "If a person wanted to learn about Rotary, the Conference was the place to be". This was a very good conference, indeed.

The following First Place Awards, were presented to the large, medium and small Rotary Clubs in the District for out standing service in categories indicated:

Club Service - Petaluma, Santa Rosa Sunrise, Windsor

Community Service - Sebastopol, Old Town Eureka, Mad River

International Service - Sebastopol, Arcata, Guerneville

Vocational Service - Petaluma, Healdsburg, Petaluma Valley

Youth Service - Santa Rosa, Arcata, Rohnert Park/Cotati

Club Bulletin - Santa Rosa West, Santa Rosa Sunrise, South Ukiah

Interact - Sebastopol, Santa Rosa East, Rohnert Park/Cotati

World Community Service - Southwest Eureka, Santa Rosa Sunrise

Homer Wood Award - for (overall) Santa Rosa Sunrise

Without question, under the leadership of Larry Bello, the Rotary year of 1997-98 was an extraordinary success. His planning and organizational ability was outstanding. His sincere loyalty to Rotary was exceeded only by his total commitment to Rotary. District 5130 became a better District with Larry as its leader.



**LOUIS G. DELSOL**  
**Rotary Club of Ukiah**

**1998 - 1999**



Lou Delsol joined over 500 other district governors in the Rotary world to support Rotary International President JAMES LACY of Cookville, Tennessee in urging us all to "Follow Your Rotary Dream." Lacy's major efforts were aimed at improving the condition of children, especially children of third-world nations, and to find more creative solutions to the stubborn problems facing them and humankind in general--thus his campaign to stimulate us to "dream big dreams' and "to make them come true."

Delsol's Local effort, his "Rotary dream," was to urge Rotarians of District 5130 to increase their commitment to the ideals of Rotary by understanding how those ideals developed into an international program. To do this, he focussed his message around two themes. One was that knowledge of the history of Rotary was basic to full understanding of Rotary's success in effecting change in the world; and the other was that participation in district and international activities increased one's pride in the organization and deepened one's desire to be part of the "international force for peace and goodwill through service."

Rotary year 1998-99 was in general dominated by two worrisome concerns: (1) a third year of declining membership and (2), a faltering Asian economy which has resulted in diminishing contributions to The Rotary Foundation by its two most generous contributors, Japan and South Korea. Thus the messages from RI Presidents, Jim Lacey and his immediate predecessor, Glen Kinross, both stressed two things: (1) the need to increase membership and to increase our contributions to The Rotary Foundation from the USA since we are benefitting from a more robust economy than the rest of the world.

In contrast to the current shortfalls, the US economy of three years ago provided sufficient funds for expenditures this year to enable President Lacy to install a \$20 million, one-year Program of Children's Opportunity Grants. These grants were made to clubs with strong projects to improve the circumstances of disadvantaged children throughout the world. Competition for these dollars by the 29,000 RI clubs was intense. Requests amounted to \$4.00 worth for every dollar available. Therefore, "early birds" and highly original, creative proposals garnered most of the dollars.

District 5130 had only two grantees receive money from this prestigious program--Lakeport and Kelseyville Sunrise. The winning of an award by Kelseyville was a remarkable achievement for this small (17 members), second-year club still in the early stages of establishing itself firmly in its community. Its success in this respect earned it special recognition at the district conference as the winner of "The Rotary Achievement of the Year" award, an acknowledgment created by the district governor to recognize the most outstanding single achievement by a club during the year.

President Lacy also promoted a worldwide effort for balanced achievement in each of the Four Avenues of Service. A club testifying that it had completed a number of projects according to criteria set up by Lacy and Rotary leadership in general were granted a Presidential Citation, a handsome certificate suitable for public display. The number of projects in each avenue of service were assigned according to club size. Although most clubs in the district qualified for recognition, only 15 made the required application to receive the citation.

Locally, DG Delsol's goals were to address the two "worrisome concerns" mentioned above--decreasing membership and the need to step up contributions to TRF. It appears that he came up "winners" in both instances. Even though the Rotary world--especially the USA--recorded another year of declining membership District 5130 was one of the few districts that did not. In fact, it grew by about 1 per cent, from 2,422 to 2,444 (as of June 1, 1999)

Regarding the concern about generally declining financial support for the Foundation, the clubs of District 5130 again "bucked the trend" by registering their largest-ever contribution to TRF of \$221,817, up about 10 per cent over last year, the previous high year in Foundation giving.



On the other hand, the lack of improvement of communications within the district was the biggest disappointment of his year, Delsol admitted. Because of lack of resources both human and financial, he did not publish a district newsletter and he felt it cost him in attendance at the District Conference. Although the Event was a success financially and programwise, he felt that an insufficient number benefited from the fellowship, inspiration and awareness of the success of Rotary during the year. As a result he believes the district advisory committee should examine ways and means to resolve the growing problem of providing sufficient inter-club communication.

Perhaps the most dramatic development during the year was to have a \$500,000 3-H grant awarded to the District, or more precisely, to the clubs of Mad River, Old Town Eureka and Rohnert Park/Cotati from which came the primary developers of the grant request. A five-year program, its purpose is to help underdeveloped areas of Nicaragua, Ecuador, and Peru to improve public health service and thereby combat childhood and other diseases that periodically ravage their populations.

The award is the largest such grant ever made to the District and is only one of the few ever awarded a Rotary entity. Key Rotarians who worked on this massive and complicated program were Dennis Ryan (author, Mad River), Dennis Kalson (technical advisor, Old Town Eureka/Santa Rosa) and Vida Jones (researcher/planner, Rohnert Park--Cotati).

For the third straight year the "Festival of Brotherhood" proved to be increasingly successful. Comprising the largest contingent to date, sixty-two Rotarians, partners and guests from Districts 5130 and 5400 (Idaho, Boise area) met in Guadalajara, Mexico, in February with Rotarian counterparts to review past cooperative efforts and plan for new ones. Attendees saw how desperate the need is for improved diet, sanitation and general living conditions for great segments of Mexico's population in its large and most affluent cities. And Mexico is only one of many developing nations with such need.

As for this year's District Conference, which was held at the 12th District Fairgrounds in Ukiah, several features should be mentioned. Its major speaker, Paul Sandas, RE Director for Zones 23 & 24, keynoted the Saturday session and brought the message to "stay the course" regarding the elimination of polio from the face of the earth, and the need to make a special effort to finance the Foundation to offset the decline of East Asian contributions. President Representative George "Curly" Galbraith, past Rotary Vice President from Calgary, Alberta, Canada, lauded 5130's commitment to youth as he saw it reflected in the presentations by RYLA Youth Exchange, Interact and numerous displays and talks by clubs.

Attendees were also regaled and inspired by James Young of Fullerton Rotary, a.k.a. Paul Harris, in which form he projected how our founder might have confronted today's problems, especially those of youth. Finally Toni Cordell of Atlanta, Georgia, told of her personal struggle with literacy and of Rotary's commitment to provide assistance in helping remedy this solvable problem that acts as a barrier to vocational and therefore personal success.

The year concluded, as usual, with the RI Convention, this year in Singapore. Again the strength of the convention is in its celebration of the internationality of Rotary, which was also exemplified by the host city itself with its reliance on world trade and the management of its diverse social order. The presentations, displays, activities and entertainment all pointed to the fact, not wholly appreciated by too many Rotarians, that the strength, power and glory of Rotary is in its worldwide commitments; for, after all name says it all--Rotary INTERNATIONAL.

Michael P. Merrill  
District Governor 1999-2000  
Theme: "Live Rotary!"  
**A Year of Firsts**

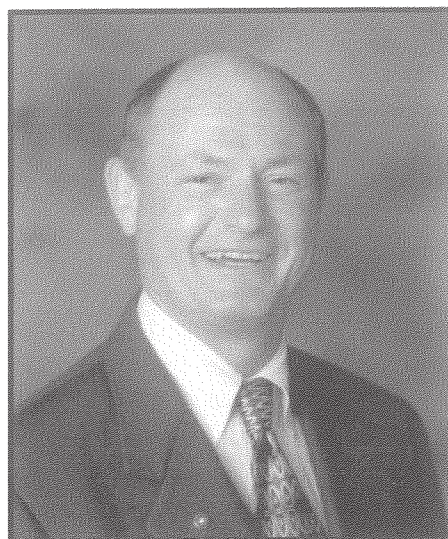

Mike brought a full and varied background to the 1999-2000 District Governor's job. He is a long-time Santa Rosa business lawyer and the senior partner of Merrill, Arnone & Jones and a founding director and vice-chairman of the board of North Coast Bank. Among other community involvements, he is a past director of the Luther Burbank Center for the Arts and a three-term president of the Sonoma County Humane Society. A graduate of the University of San Francisco and the USF School of Law, Mike is a former Marine Corps Captain who served a tour of duty in Vietnam.

Mike first joined the Rotary Club of Santa Rosa West in the late 1970's. When he served as President in 1994-95, his club launched its first multi-year service project, taking the lead in fund-raising for a \$500,000 preschool building.

#### Ambitious Goals

Mike's theme, "Live Rotary!" speaks for itself. The end of the millennium and the century was a turning point for our District, as Mike and his team set an ambitious agenda for the year.

**A landmark year for leadership development.** Our district took to heart the theme of 1999-2000 Rotary International President Carlo Ravizza: "Consistency, Credibility & Continuity."

A new type of leadership team became a hallmark of the year. For the first time in our district, Mike named the equivalent of three Assistant Governors to facilitate communication, assist clubs in accessing district and Rotary International resources, and to promote the development of leadership within the district. They were Bruce Campbell (Sebastopol Sunrise), Terri Clark (Southwest Eureka), and Franz Wartenweiler (Napa Sunrise). This structure facilitated new teamwork between Rotary Clubs and Rotarians, and created paths for broad leadership participation.

Mike initiated leadership meetings that included top aides, district officers, committee chairs, his successor Harry Johnson, and Past District Governors. These gatherings established camaraderie, clarified our shared purposes, and generated ideas. They also provided an opportunity to review plans and policies in a collaborative and positive environment.

A major achievement of the year was the adoption of our first District Leadership Plan, which formalized the position of Assistant Governors and a leadership development structure.

**The first major district project.** After requests for ideas, and discussion among district leadership, Cool Kids Camp was established with the inspiration of Tom Farrell and a dedicated committee. Sebastopol Rotary, led by president Brad Benedetti, contributed seed money for the first camp project.

**Membership growth and a new club.** Our rolls grew 3% at a time when Rotary membership declined slightly in California. A highlight of this progress was the rapid organization of the new Rotary Club of Santa Rosa Oakmont, led by PDG Norm Lawrence and assisted by Bruce Campbell and charter president Dennis DeSousa.

**Permanent Fund.** We saw a leap in the numbers of District 5130 Benefactors, as 135



generous Rotarians and partners became Benefactors for the first time.

**Communication.** The District made improved use of its award-winning web site, [www.rotary5130.org](http://www.rotary5130.org), and several clubs developed sites of their own. Mike used the Internet and e-mail extensively, sending Guv-Grams to club presidents and secretaries electronically whenever possible. His Governor's Newsletter, The Wheel News, was mailed to each Rotarian and duplicated on the web site.

### Partnership and Travel

Mike was our first DG to have a Rotarian wife, Maureen McDaniel, a member of the Rotary Club of Windsor since 1987. Maureen accompanied Mike on each club visit, edited his newsletter, and designed the visual presentation that accompanied his message to clubs.

The two saw a lot of travel during the year, beginning with the June 1999 Rotary International Convention in Singapore. In January, they visited southern India to participate in a National Immunization Day for Polio Plus, and to attend the district conference in Salem, India with our GSE team. As a result of this tour, and with the support of GSE Team Leader Rebecca Smith of Sebastopol, the two districts embarked on nine World Community Service and Matching Grant projects.

In February, Mike and Maureen joined district Rotarians at the Festival of Brotherhood IV in Guadalajara, Mexico. The festival resulted in several new WCS matching grants. In addition, over \$3,500 was raised for the Rotary Foundation on behalf of District 4150, through the joint efforts of participants from our district and the Mexican Rotarians.

In spring, Mike and Maureen offered a new club presentation, "Living Rotary International", sharing their observations and experiences with The Rotary Foundation with several clubs. Following these visits, dozens of Rotarians signed Benefactor cards for the first time.

While in Argentina for June 2000's Rotary International Convention in Buenos Aires, they visited a former exchange student at his university in Cordoba, and enjoyed dinner with the Rotary Club which had sent Leandro to their home some years before.

### A Loss to the District

November 1999 saw the death of Past District Governor (1997-98) Larry Bello. Larry was active in Rotary affairs and in forming the new Oakmont club until three weeks before he died. He regularly attended Mike's leadership meetings, and encouraged him toward his goals.

### A District Conference Like No Other

The unique May 2000 District Conference was conducted partly in Santa Rosa, and partly at sea on a cruise ship from San Francisco to Vancouver, B.C., with District 5140 (Marin and San Francisco.) Our keynote speaker on land was Swami Suddhananda of Madras, who spoke on personal fulfillment through philanthropy. We were honored to have on the cruise with us, and as conference speakers, both R.I. President-Nominee Rick King, and renowned Foundation speaker John Capps III, and their wives, Cherie and Jane.

### Awards

Clubs of the Year were Sebastopol (large club), Santa Rosa Sunrise (medium-sized club, for the second year in a row) and Mad River (small club). The Rotarian of the Year was Bruce Campbell of Sebastopol Sunrise, and the New Rotarian of the Year was Janice Newman of Arcata Sunrise.



Harry N. Johnson, D.D.S.

2000-2001

Harry was an enthusiastic Rotarian. During his presidency of the Rotary Club of Arcata Sunrise he brought the club from 31 members to 44. He introduced the community service project called "Skid Lids for Kids". He introduced his club to the Rotary Youth Exchange program. His experience on nine different district committees and chair or Co-chair of two gave him the knowledge of Rotary.



Harry's enthusiasm was expressed as he asked the Rotarians of District 5130 to "Know Rotary-Show Rotary". As they embraced Rotary International President Frank Devlyn's theme of, "Create Awareness- Take Action". Harry stressed that to be successful as volunteers we must be rewarded. Rewarded with "thanks", rewarded with "fun" and rewarded with "recognition". He changed the Governor's visit format. We enjoyed an evening or afternoon of camaraderie, exchanging ideas as he relaxed the formal protocol of the "inquisitive" Governor. Harry expressed in his club visits that he was no more the automotive part called the "governor", but would much prefer to be the "generator" and recharge our Rotary battery.

Harry's history as a successful dentist and real-estate investor/developer had created certain business characteristics that proved beneficial to District 5130. The turn of the century gave credence to the "Team 2000" concept. Governor Harry joined with District 5010 Governor Phil Livingston to adopt a theme oriented GSE team. The two districts exchanged health care professionals. The proof of this new concept would be in the pudding as nearly \$500,000 in medical equipment and supplies has been provided by Californians to Siberian medical facilities. The Rotary Club of Eureka, with the guidance of its 2000-01 President Dr. Kim Bauridel has and continues to be the centerfold of those worthy projects. The extra travel expense for this novel GSE experience were more than funded by the 350 "Team 2000" jackets that supportive D5130 Rotarians purchased. World Community service did not end there. Every club in District 5130 participated in a World Community Service project. Under the watchful eye of Southwest Eureka Rotarian Jay Sooter, over 30 World Community Service (WCS) projects were submitted and 19 came to fruition. This was Rotary International's first year for Community Assistance Projects (CAP). Throughout the 531 districts in Rotary only 321 such projects were approved; District 5130 had 10 of those projects! This program allowed for local projects to receive Rotary Foundation funding! The tragic earthquakes of western India and Ecuador brought the Rotarians Bruce Campbell of the Rotary Club of Sebastopol Sunrise, Stan Smith of Old Town Eureka Rotary and PDG John Strong of the Rotary Club of Petaluma Valley to their feet as they led the district wide march to a near \$60,000 relief drive. Further action was taken as our district significantly helped fund a National Immunization Day (NID) in Ghana. Mad River Rotarian Eleanor Sullivan joined with South Ukiah Rotarian Charlie Kelly to join the team in this central African nation and administer the lifesaving drops to hundreds as 3.5 million children were immunized in one day.

Those contributions were above and beyond. Governor Harry had asked the Rotarians of D5130 to find it in their hearts to contribute an average of \$101 to the Rotary Foundation Annual fund.

The Rotary Foundation Annual fund received \$100.62 per capita! For accounting purposes we round that to \$101! At the same time the number of Rotary Foundation Benefactors doubled, 10 new Bequest Society members and 4 new Major Donors.

Governor Harry and his wife Sheryl were charter members of the Festival of Brotherhood and attended 5 years. They have also volunteered their dental services to orphans and needy indigenous children in the state of Colima, Mexico for 15 years. Harry developed a dental clinic in the small mountain village of Cofradia de Suchitlan. He did this with the help of numerous Rotary clubs and Rotarians in Washington, Oregon, Utah and Mexico, but mostly with the help of the Rotary Club of Arcata Sunrise.

Let there be no mistake. Rotarians of D5130 did not forget their local neighbors in 2000-01. The Cool Kids camp in Sonoma county began to find roots in the northern section of the district, RYLA flourished with 100% club participation, Youth Exchange grew under the loving care of Garberville Rotarian Chris Brannan, Interact had a notable presence at the District Conference. During Harry's year the concept of Governor's Area Representatives (AR) was to transition to a format of District Club Coordinators (DCC) and Assistant Governors (AG). This leadership program adopted by RI was designed to broaden the leadership exposure and lessen the demands on the District Governor. As this is written the certainty is yet unknown!

In the year 1999-2000 the ebb in Rotary's membership tide had turned. In 2000-01 there was a small increase in membership. Unfortunately we lost forever PDG Stanley I. Lance, 1966-67 he will forever be appreciated for his service.

Appreciation is all we get. Rotarian Charlie Kelly is appreciated for his great service to Rotary in 2000-01, thus named Rotarian of the Year. Rotarian Kenny Parlet II of Lakeport Rotary and Rotarian Craig Newman of Arcata Sunrise shared the honor of being named to the D5130 Hall of Fame. A tremendous member of the Rotary club of Petaluma Valley, Charmaine Stouder was selected as the "New Rotarian of the Year".

The dream of every district Governor is a successful District Conference, Many Rotarians were responsible for the success of the 2001 D5130 Conference at Konocti Harbor in Lake County. real leaders were Kenny Parlet II and PDG Cam Reeves both of the Rotary Club of Lakeport As Rotary International President representative Walter Maddocks observed the process two other Rotarians were given great honors by Rotary International. For his many Rotary Services to Rotary Dennis Ryan, Mad River Rotary, was awarded Rotary International's highest award, "Service Above Self". PDG John Strong of Petaluma Valley was awarded the Rotary Foundation's most prestigious award, "The Citation for Meritorious Service".

An all time record was achieved in 2000-01, of the 43 Rotary clubs in D5130 the Rotary International Presidential Citation was awarded to 29 clubs!

The Rotary Club of Petaluma was awarded the RI Public Relations Award. The Rotary Club of Sebastopol earned the RI Significant Achievement Award as Garberville was honored with the Foundation benefactor Award and Arcata Sunrise the Paul Harris Award

The Conference was closed with the Parade of Nations by the Rotary Youth Exchange. A program founded in D5130 by PDG Dave Dillon, developed by South Ukiah Rotarian Roger Coate, loved and supported by Governor Harry N. Johnson.

It was a good year!

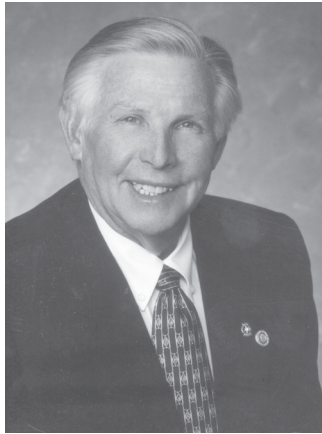

Franz A. Wartenweiler  
District Governor 2001-2002

Franz's theme, "Experience Global Rotary" emphasizes the worldly size of Rotary International. All clubs must look beyond the local area and encompass the entire International aspect of Rotary.

A Rotarian since 1972, first in the St. Helena, Rotary Club and President in 1981-1982 then a member of the Napa Sunrise Rotary club. Franz had a successful Chiropractic practice in St. Helena for 25 years. He founded the Napa Valley Chiropractic Association and became its first President serving two years. He was a member of the International Chiropractic Association, Gonstead Clinical Study Society, Renaissance leader, Toastmasters (founded the first Toastmasters club in Davenport, Iowa.), served on the Napa County Grand Jury, member of the vestry for St. Marie's Episcopal Church, served on the Board of Directors for the British American Club of Northern California and helped numerous volunteer and school committees.

The Rotary year 2001-2002 was lead by Rotary International President Richard King. Rick's slogan "Mankind is our Business" and dream for RI was to increase membership for the first time in four years. District 5130 was one of 50 clubs internationally to meet its Goal of increasing its net membership by 300 members. District 5130 received an award on stage at the International Convention in Barcelona, Spain along with 49 other clubs. This was a great recognition of hard and enthusiastic work of every club within District 5130.

Foundation giving was also of an all time high and District 5130 received another award at the Zone Institute being 3<sup>rd</sup> out 22 districts to accomplish its goal of foundation giving.

The District Leadership Plan was introduced during Franz's governorship. This was the transition into grooming district leaders by appointing Assistant Governors (6) and District Club Coordinators (9). The Leadership Plan is still functioning well and has produced many new Governors.

During this year we saw a Group Study Exchange with Japan. Franz was invited to the 2630 District Conference in Japan and we hosted District 2630 Governor, Takashi Yoshida at our District Conference in Napa/Yountville.

The District Conference was held in Napa and at the California Veterans Home. Our motto was "Saluting America's Heroes" and there was no better place to do this than at the oldest and largest Veterans Home in the State of California. This conference was a wonderful way of celebrating a great year in Rotary and introducing a new year of Service in Rotary.



**Terri Clark**  
**2002-2003 Governor**  
**Bhichai Rattakul, Rotary International President**



On November 18, 2000, the nominating committee of District 5130 made the historic selection of its first woman District Governor. Terri Clark joined the Rotary Club of Southwest Eureka in 1992; she was appointed to the board of directors in 1994, and elected President 1997-98. She was president when the late Larry Bello was DG, and appreciated the leadership he provided. She served as an Area Representative under DG Lou Delsol. She was one of the first 3 Assistant Governors in District 5130, even though the position was called "Zone Aide" when DG Mike Merrill created it in 1999.

Born in Long Beach, Terri was the first of 5 children in her family. Her father's Navy career took them to San Diego, North Chicago, Japan, Monterey and Rhode Island before she turned 18. She attended 13 schools before graduating high school in 1971. This life gave her wanderlust as well as a desire for "roots"-- not to mention the ability to begin conversations with complete strangers! She moved to Humboldt County in 1974 to attend Humboldt State University and met her husband, Marty Lay, in 1977. They married 5 years later and have continued to live in their beautiful part of the world except for the 6 months they spent in Sonoma County...another beautiful part of the world.

When she joined Rotary, she found a "home" for her love of service and fellowship. She is proud of the contributions her Club and the entire organization make both locally and internationally. She and Marty are both committed supporters of The Rotary Foundation; they are multiple Paul Harris Fellows, benefactors and charter members of the Bequest Society. She is also an avid RI convention attendee, having attended her first in 1997 when she was an incoming Club President. Marty has attended those held in San Antonio, Barcelona and Brisbane and loves the international fellowship! They have both participated in several Festivals of Brotherhood, a project fair held in Guadalajara.

Her year as District Governor was marked and shaped by the goal of completing the Polio Eradication Campaign that Rotary had begun many years earlier. When she and Marty attended the International Assembly in Anaheim in January of 2002, they heard President Elect Bhichai Rattakul speak of the quest to see polio eradicated by Rotary's Centennial in 2005. The 530 DGE's in the room were asked to go home and appoint a Past District Governor to head the campaign in their District. Terri immediately thought of Larry Myers and wondered if he would say yes to such a huge task. He did and in the same breath, said "and you knew I'd had polio as a boy, didn't you?" She had not known that but by the end of her term as Governor, everyone in the District had been touched by his amazing story.

Among her official goals were "have fun" and "dance". She published the "straight" goals too, but she wanted to emphasize the fellowship that brings great service. She even got PDG Del Raby out on the dance floor at her District Assembly in April 2002! She set a 2-part Rotary Foundation goal: \$125 per capita for annual giving and \$78 per capita for Polio Eradication. Each person who met that combined goal got a beautiful Double Sustainer pin. Besides having fun and dancing, she has always thought jewelry is a good idea! She had a new District pin designed and also distributed the famous Kahuna pins, conceived by and designed for the Zone 23/24 2002-2003 Governors, nicknamed the "Luv Guv's" in recognition of President Bhichai's theme of "Sow the Seeds of Love".

Her first month in office saw the first Cool Kids Camp North. The Rotary Club of Sebastopol had begun the camp in Sonoma County as a week where abused children could have a true camp experience away from the harsh realities of their everyday lives. She made many of her official visits and learned something new each time she sat with a Club board and heard how they were making a difference in the world. By August, 700 of the Double Sustainer pins were in the hands of Rotarians in District 5130; that meant that over \$140,000 had been donated to the Rotary Foundation in just the first 2 months of the Rotary year. And it got better...

An important part of every Governor's job is to arrange a Group Study Exchange. The selection of the country is left to the DG and until the 2002-2003 Rotary year, the entire exchange had been funded by the Rotary Foundation with no contribution of DDF by a District. Terri was committed to both parts of the exchange occurring while she was DG so she allocated the necessary DDF; beyond that, she was thrilled to be part of the first non-Rotary country, multi-District

GSE! Four Districts (5030, 5150, 5130 and 5170) received special permission from TRF to have GSE with Vietnam and the planning took a great deal of her time throughout her DGE and DG years. In September, the GSE committee selected Larry Connolly of the RC of Arcata to be the team leader.

By early October, she had visited 37 of the 43 Clubs and had the privilege of telling Assistant Governor Bruce Campbell of the RC of Sebastopol Sunrise that he would be Centennial Governor! At the end of the month, 275 people attended the Foundation Dinner North and she gave her final official speech to her own Club. Four of her predecessor Governors were there that day and she was honored by their presence. At the 2 Foundation events, over \$30,000 was raised for Polio Eradication through live and silent auctions. In November, she and 3 other Rotarians from our District attended a Conference on Poverty in the Americas in San Diego and heard PRIP Frank Devlyn inspire everyone in the room.

In early January, over 1000 people attended a dinner in honor of President Bhichai in Monterey. Terri gave the invocation and she and Marty enjoyed a private breakfast with her classmates and the President the next morning. He is a delightful man and inspirational leader. She was grateful each day that she could be DG during his presidency. In February, Terri and Marty traveled to Guadalajara for Festival of Brotherhood and enjoyed the fellowship of the Rotarians there as well as the chance to see projects that needed help through Matching Grants. Also in February, we learned that District 5130 was #20 in the entire world in total contributions to the Rotary Foundation! It was tribute to the response of our Rotarians to both the Polio Eradication Campaign and the need for the programs funded by Annual Giving.

By March, it seemed like the train called a DG's year was approaching warp speed! On March 2<sup>nd</sup>, Terri had dinner in San Francisco with 2 of her classmates, DGN Bruce, 4 GSE team leaders and 16 GSE team members. The GSE teams left for Vietnam that night and if she could have stowed away on the plane, she would have! That week she learned that the RI rep to her Conference would be PRID Benny Santos, who had been instrumental in the first ever NID, held in his country, Philippines. Conference promotion was going full on, and her awesome committee conceived the idea of a cash prize to the Club in each County who had the highest number of registrants at the Conference.

In April, Terri and the DG's from Districts 5150 and 5170 waited outside the international arrival gate at SFO, watching their incoming teams arrive from Vietnam. In spite of the outbreak of SARS and many passport/visa issues, the exchange happened and what a delightful month the entire District had with Phat, Ha, Huong, Hieu and Quyen! They called all of their host families "Daddy" and "Mommy"; Terri was "Big Cheese" and Marty was "Daddy Cool". We learned from each other every day.

The District Conference was a truly international event. Patricia Hewitson from Australia and Nagarjun Devaraj from India, 2 members of the first class of Rotary Peace Scholars, were there, as was the GSE team and the wondrous Benny Santos from Philippines. 655 people attended some part of the Conference. At the closing breakfast, the GSE team told the Rotarians what they'd learned about Rotary and the USA and had everyone in tears of joy at having met them and sadness at saying goodbye to them. Martin Zepp of the Rotary Club of Guerneville was New Rotarian of the Year and DG Terri named Larry Myers Rotarian of the Year for his tireless work on Polio Eradication. Small Club of the Year was Guerneville, medium was Sunrise Rotary Club of Arcata, and there was a tie for Large Club of the Year between Sebastopol and Petaluma.

Marty and Terri wound up their travel schedule in Brisbane for the Rotary International convention and what a party it was! The hospitality shown the Rotarians by everyone in Australia was phenomenal. At the plenary session on June 3, 2003, the announcement everyone had awaited was made: "Rotarians have contributed more than \$80 million in 2002-03 toward the Eradication of Polio." The celebration began in earnest! At the closing session, President Bhichai made the most personal, moving and heartfelt speech Terri had ever heard, telling the audience of his love for Rotary and his pride in what had been accomplished that year.

At Saturday night's dinner at the District Conference, before she gave the major awards, DG Terri told the people gathered there that her year as DG had been a "journey of great joy". Although it officially ended June 30, 2003, the best news came 3 weeks later. During 2002-2003, District 5130 contributed over \$610,000 to the Rotary Foundation. It was a splendid finale to the year.

**NORMAN M. OWEN**  
**DISTRICT 5130 GOVERNOR 2003-04**

In his service to Rotary as District Governor, Norm applied his broad and varied educational and employment background, as well as his experience in international, community, professional and Rotary service. A long-time real estate and business lawyer in Sonoma County with a multi-state practice background in title insurance and escrow, Norm has been involved in service on a variety of boards and commissions, and is a past international president of the world's largest International law fraternity and its public service Corporation, as well as serving on the state-wide California Governor's Committee for the Employment of People with Disabilities.



Norm served in the U.S. Army, graduated from United States International University with a BA Degree, cum laude, and a California elementary school teaching credential. Norm is a graduate of California Western University School of Law.

Norm joined the Rotary Club of Santa Rosa in 1978 where he served as a director and on numerous committees. In 1996-97 Norm served as Club President. In celebration of the Club's 75<sup>th</sup> Anniversary that year, the first Club History was published.

Nominated to serve as District Governor in September 2001, in 2002 Norm attended the Governor Nominee Training Seminar in Palm Springs. Shortly thereafter Norm was diagnosed with colon cancer. However, while he was in treatment and as his health improved, he conducted training sessions for his leadership team with the assistance of District Trainer, PDG Mike Merrill, and Norm's Chief Assistant Governor, Steve Olson. Then it was on to the Multi-District Presidents Elect Training Seminar (PETS) in San Jose for training incoming 2003-04 Presidents.

Following PETS, the District Assembly was held at Mendocino College. This well attended, motivating Assembly and the Rotary Theme for the 2003-2004 year--Lend a Hand--chosen by RI President Jonathan B. Majiyagbe inspired the attendees and set the tone for one of our District's and RI's banner years. Another key element of the enthusiasm created there was the emphasis placed on "The Family of Rotary" by RIP Jonathan, Norm and his wife and Rotary partner, Beverly, which was emphasized throughout the Rotary year. Norm also stressed the importance of communication and encouraged "cross-pollination" of ideas and club-to-club interaction through his weekly newsletter to the Club Presidents and over the District website, entitled "News from Norm". This widely read publication often resulted in inter-club participation in fundraisers and social events, engendering further the "Family of Rotary" concept District-wide.

In their visits to each of the Clubs in the District, Norm and Beverly each made a presentation on Lending-a-Hand and stressed the importance of the Family of Rotary.

Norm's emphasis on communication was conveyed in each of two Foundation Seminars, as well as in three Membership Seminars, focused on Lending-a-Hand through Foundation giving, and the importance of the Foundation in accomplishing the work of Rotary throughout the World.

Because of the continuing confusion among many of the Clubs and the District Leadership Team about the structure and effectiveness of the District Leadership Plan, Norm formed a Plan Review Committee of the three immediate Past District Governors who had served since the Plan's passage, and one each of a Current Assistant Governor, District Club Coordinator and one sitting Committee Chair and Chaired by the Chief Assistant Governor. The report of this Committee was then forwarded to the District Advisory Board for further review.

In November 2003, Beverly and Norm attended the Festival of Brotherhood in District 4150 in Mexico with 60 District 5130 Rotarians to review projects that could improve conditions in District 4150 as well as to continue to foster a sister-district relationship between the two Districts. 2003-04 also witnessed an increase in District Sponsorship of Rotary Peace Scholars with several Club and District events attended by Peace Scholars.



Youth Exchange was again a highlight of this Rotary year. RYLA flourished, and the Interact Conference inspired our high school and junior high school youth. A new Rotaract Club was chartered in the Greater Santa Rosa area.

Group Study Exchange witnessed a great exchange of teams between Brazilian District 4430 in Sao Paulo and District 5130.

The Clubs also embraced the "Every Rotarian, Every Year" concept, as contributions to the Rotary Foundation from our Rotarians exceeded \$100 per capita.

There were outstanding Membership Seminars in three separate areas of the District which improved membership recruitment and retention awareness and enabled the Clubs to hold their own in membership while other similar organizations were experiencing declining membership.

During this Rotary year, the Clubs' great imagination and dedication in initiating and planning was done to assure Centennial Projects for the Centennial celebration of Rotary in the succeeding year would include a project from each and every Club in our District.

On April 16-17, 2004, District Governor Elect, Bruce Campbell, held his District Assembly for the 2004-05 Centennial Year of Rotary at the College of the Redwoods in Humboldt County.

In May 22-26, 2004, the Rotary International Convention held in Osaka, Japan was one of the most well attended Conventions in the history of Rotary.

The "Imagine" District Conference held at the new Vineyard Creek Hotel and Conference Center June 17-20, 2004 in Santa Rosa was a true celebration of the accomplishments of the Clubs and boasted outstanding attendance and camaraderie, where each attendee received a "Souvenir Commemorative Program" chronicling the Clubs' projects and accomplishments throughout the year, a pictorial directory of RI and District leadership, and photographs and biographical information on the featured speakers for the Conference, as well as the highlights of the year, including those referenced above, plus a District 5130 Centennial Poster Contest Winner, the first ever awarded Simplified Grants to Clubs' for local projects, the continued success of Cool Kids Camp and the expansion of this outstanding program to Cool Kids Camp North. In addition, a scholarship for students with disabilities to attend a State-wide "Youth Leadership Forum" conducted each year by the California Governor's Committee on the Employment of People with Disabilities was initiated by Norm. The sponsorship of Clubs in support of the "Every 15 Minutes" program was very successful; and, of course, the District-wide Dictionary Project put 15,680 more dictionaries in the hands of third graders in the District.

The annual Bru Branier pre-conference golf tournament was a fitting jump-start for the Conference, as well as the renewal of District friendships.

The Imagine Conference Opening Session began with the inspirational presentation of the Flags of the Nations of the Rotary World by our Youth, followed by the presentation of the first ever Lawrence P. "Larry" Bello, PDG, Vocational Scholarship by Larry Bello's widow, Nancy, punctuated by the opening address by PDG John Blount. The afternoon sessions focused on Youth and International Service, followed by a western-style evening of dinner and dancing, including a welcome from RI President Jonathan's representative, District 5330 PDG Milt Levinson, and the Youth Exchange students' presentation.

Saturday's programming focused on looking back to benefit future planning, the Rotary Foundation, Club and Community Service, and the Business of Rotary. Our luncheon keynoter was Jeri Jewell, an actress, comedienne and motivational speaker who touched our "collective imaginations" and our hearts. The dinner program was a tribute to our 2003-04 leadership and awards ceremony honoring the year, and an introduction of the 2004-05 leadership, followed by the DG Exchange of pins. As a tribute to Jeri Jewell for her courage and her inspiration, \$3000 was raised by the attendees for The Rotary Foundation to be contributed in her name.

Steven Olson received the District Rotarian of the Year award.

Sunday began with an ecumenical service, followed by the Closing Session on Rotary Excellence and a Special Tribute to Fathers. Norm closed this Imagine Conference with his thanks to the outstanding service of the remarkable District 5130 Rotarians and their families.

**Bruce Campbell**  
**2004-2005 Centennial Governor**  
Glenn Estis, Rotary International President



Bruce first joined the Rotary Club of Sebastopol in 1979 where his father Ad Campbell was secretary. He was active in the club but a business move took him to Florida in 1984 where he was on the charter Board of Directors of the Rotary Club of Boca Raton West. Just prior to begin serving as President-Elect for that club business once again returned him to California and he located back in Sebastopol. Rejoining the Rotary Club of Sebastopol he served on the Board of Directors and when the secretary of the club became ill and was no longer able to serve, he filled in as Acting Secretary for several years before becoming secretary. He and his wife Helaine, who became a Rotarian in 1991, served as conference registration chair for DG John Blount.

Several years later, while Helaine was serving on the club expansion committee, Bruce volunteered to be the DG special representative and develop a new, morning club in Sebastopol. In May 1997, after 3 months of effort, the Rotary Club of Sebastopol Sunrise was chartered with Bruce as Charter President on the same day as their sponsoring club, May 26 with 30 charter members.

Bruce was born in upstate New York, raised in suburban New York City and went to college in California, CalTech and Baltimore, Johns Hopkins. He graduated with a degree in Physics and a commission in the US Army Reserve. He was stationed after basic officer's training at Fort Mason for 2 years.

Bruce served as an Area representative for DG Lou Delsol and in 1999 was on of the first three Assistant Governors for District 5130 then called "Zone Aide" for DG Mike Merrill. He continued to serve both his club and the District, serving as AG for DR Harry Johnson and then as District Secretary for half a year for DG Franz Wartenweiler.

When Terri Clark was selected to be DG in 2002-2003, she asked Bruce to be an Assistant Governor one again. The following year, then DG Terri was the one who announced that he had been selected Governor Nominee for the Centennial year of Rotary. Leading up to the year he served as Governor were two years of training and planning during which Bruce made it a point to visit each club in the district to learn about them.

The Centennial year really began at the International Assembly where Bruce and Helaine met once again with the other Governors Elect and prepared for PETS. The District Assembly was held at the College of the Redwoods in Fortuna with a wonderful dinner at the historic Scotia Inn. When the year really began, it was busy with the club visits and club events that took place during the summer and early fall. The weather played a bit of

havoc with the Foundation celebration in the south but the clubs up north made up for it with a grand Masked Ball.

The year was going along somewhat uneventful until the day after Christmas when word of a tsunami in the Far East was received. Over the next several months, Rotarians from the district not only raised over \$120,000 for relief efforts but many went to the affected region to assist with the relief and recovery work. The moneys raised were distributed to 4 affected areas and the local Rotary Clubs there to assist them in their communities. Three of the 4 have used the money for school projects and the fourth in India for a pediatric ward in a local hospital.

During the course of the year, each of the clubs in the Districts developed and implemented a "Centennial Project" to properly recognize the 100 years of Rotary's existence. These projects will remain as a reminder of the good that the 2500 Rotarians do in District 5130.

On the international level, members of the District joined with members of District 4150 in Mexico for another Festival of Brotherhood. As a result of this 10 day festival of friendship and project fairs, numerous matching grants were proposed and support obtained from the Rotary Foundation. A Centennial Group Study Exchange was held with the Siberia and Far East Russia portion of District 5010. When the Russians were present at the District Conference in Rohnert Park, one of the members of the team presented DG Bruce with 10 crisp \$100 bills and said he wished to become a Paul Harris Fellow. It was learned later that when he returned to Russia, he was asked to joined Rotary and became the first Paul Harris Fellow in his new club.

Locally the year came to a close with the very successful and well attended conference focusing on Around the World with Rotary. Club efforts both locally through out the world were highlighted. Three Rotarians, Joe Lindland, Joe Dacaney and Tom Allman were recognized for their tsunami work as the Rotarians of the Year. .

Shortly after the conference a large number of District Rotarians converged on Chicago where they joined with Rotarians from around the world to complete the year of Celebrating Rotary.



## Charlie Kelly 2005 – 2006

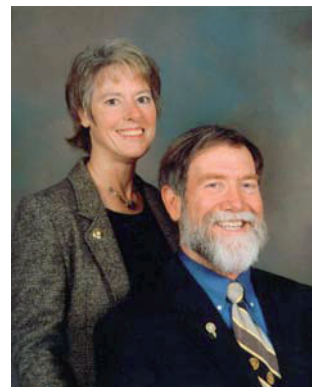

RI President Carl-Wilhelm Stenhammer chose, as the theme for this year, the motto that has guided us for decades “**Service above Self**”. In his address to incoming District Governors, he urged all Rotarians to “return to our roots” – to re-dedicate ourselves to the basic tenets of our 100 year old organization, the oldest service club in the world.

DG Charlie visited all 43 of the Clubs in the District in as short a time as seemed possible, in order to spread that message. In his remarks to the Clubs, Charlie gave a brief history of our organization, quoting liberally from the book “A Century of Service”. Charlie asked that every Rotarian find something to do for others, whether in their families, their Clubs, their communities, or the World. If that would happen, we would all help “write the first chapter of the history of our second hundred years - and it would be a *big* chapter”!

District 5130 Rotarians continued to increase their support of our **Rotary Foundation**, as *total contributions (including restricted giving and Permanent Fund)* for the year surpassed **\$413,000**. While the cumulative club *goals* for Annual Giving totaled about \$272,000, the actual amount donated was over \$344,000 - **127%** of that goal –or *\$137 per capita*.

As we are always happy to point out, all of our contributions will be put to use (in the 3<sup>rd</sup> year after their donation) in serving others – with over \$173,000 going to the World Fund, and a like amount to the District Designated Fund (a portion of which now can be used locally, as well as internationally).

**District Simplified Grants** were used by 28 of our 43 Clubs, in amounts ranging from \$650 to \$1,500 (the maximum we were able to use, based on the total available and the expected number of applications). Our Rotary Foundation funded just over \$29,000 in DSGs, this year.

**Matching Grants** from our Rotary Foundation provided over \$450,000 in real dollars, including Club and District contributions. Given the amount of volunteer labor and other in-kind donations, the total value to our International beneficiaries would likely be greater than a million dollars. 25 D5130 Clubs were involved in 18 projects with D4150 (created at The Festival of Brotherhood), plus 7 other international projects.

The 10<sup>th</sup> annual **Festival of Brotherhood**, with D4150 in central Mexico, was enjoyed by about 60 D5130 Rotarians and family members, including DG Charlie and Joan. Every year, our connection grows stronger, as we partake of that district’s incredible hospitality, and we see both completed projects as well as potential new opportunities for co-operative service.

We were pleased to charter a new **Interact Club**, thanks to the Clearlake Rotary Club’s sponsorship of Carlé High School. The annual Interact Conference, at Alliance Redwoods, had over 200 participants, from 28 of our District’s nearly 40 Interact Clubs.

At the suggestion of **PDG** (and Eagle Scout) **Del Raby** (92-93), Charlie (also an Eagle Scout) urged District Rotarians to fund the expenses of two scouts to go to the International Scouting Jamboree (to be held in 2007). One Scout was chosen from District 5130, and one was chosen from the Philippines (likely neither would have been able to attend, were it not for our support).

**Membership** in the District gained slightly, although several clubs had outstanding success in attracting new members – with both Healdsburg and Sebastopol Sunrise inducting 15 new members during the year. Del Norte Sunrise reversed a declining trend, and exceptional growth was noted in the above two Clubs, as well as Mendocino, Santa Rosa East, Santa Rosa Sunrise, Arcata Sunrise, and Valley of the Moon.

The **Dictionary Project** grew tremendously – and spread beyond our District. While it began as an ambitious local project of the Rotary Club of Petaluma (which distributed about 2,000 dictionaries to third-graders in the club’s neighborhood over the first three years), look at the statistics for this year:

Over 27,000 Dictionaries were delivered to third-graders by 99 Clubs:

36 of our District’s 43 Clubs, plus

51 other Clubs in California, outside our District, and even

12 Clubs out of state, including Hawaii

This great experience - for both Rotarians and third-grader recipients – was made possible by the dedication of an incredible man – **Harvey Freetly** (*Petaluma*). At the District Conference, there was a tremendous and enthusiastic ovation as Harvey was named the **District 5130 Rotarian of the Year**.

The outstanding and ongoing dedication to Rotary service of another individual was recognized with the promotion to the **District 5130 Hall of Fame** for **Jake Scheideman** (*St. Helena*). Jake continues to travel to Nicaragua, with many Rotarians - *and non-Rotarians* – to build sturdy homes for families there. In honor of Jake’s club, the area is now known among the locals as Santa Helenacita (little St. Helena), and there is a beautiful Rotary blue water tower with our Rotary gear serving the community

Last year, a horrific tsunami in SE Asia caused catastrophic devastation, loss of life, and immense cost – and D5130 met the call for support. This year, Hurricane Katrina hit our own gulf states, especially Mississippi and Louisiana, with billions of dollars in damages. And, once again, D5130 Rotarians opened their hearts and wallets (and even a few homes were offered for displaced refugees). **PDG Harry Johnson** (Arcata Sunrise) led a group of Clubs in the northern part of our District to create a fund-raising auction to raise relief funds (about \$16,000). Many clubs throughout the District put on special events or re-directed internal funds, towards further relief (*e.g.*, Petaluma Valley - \$11,000; Sebastopol - \$5,200; Napa Sunrise - \$10,000). And several Clubs forged one-on-one relationships with clubs (and people) in the devastated areas.

Another memorable quote from RI President Carl-Wilhelm: *“I have a dream – that every 17 year old in the World would be a Rotary Exchange Student; if that dream came true, there would be no more war”*. District 5130’s Youth Exchange program continues its pre-eminent position as the model of “how it’s done” – with a very dedicated committee led for several years by **Chris Brannan**, with great assistance from **Roger Coate**, **Cam Appleton**, **Janice & Craig Newman**, and others. As usual we sent, and hosted, about two dozen students each way (and DG Charlie & Joan hosted their 10<sup>th</sup> student).

Beginning with his District Assembly, and winding up with the District Conference, Charlie stressed “The Power of One” and “The One-der of Rotary”. A much-used quotation says it all *“I can’t do everything, but I can do something; and what I can do, I should do, and what I should do, I must do”*. District 5130 Rotarians continue to step up that challenge, as there are hundreds of ONE-derful people in our District, helping others near and far, whether neighbors or strangers.

## **DG Erna Stevenson 2006-2007**

When our Rotary International President William “Bill” Boyd, from Auckland New Zealand, asked us to “**Lead the Way**”, our Rotarians stepped up to the plate. Projects focused on clean water, health and hunger, literacy, the Family of Rotary, and so much more. George and I felt privileged to have had the opportunity to represent District 5130. What an exciting, wonderful year and we will cherish those memories for the rest of our lives.



Our District Conference, “Cirque du Rotary” was phenomenal. RIVP Jerry Hall and Tasha were able to attend, with Jerry giving an inspiring speech Saturday evening. The RI President’s Representative, PDG Hal Darcey and Lei were also an inspiration. Motorcycle Bob Mutchler shared with us his fight with Polio and the need to continue our commitment to eradicate Polio forever. Of course, the Conference would not have been the success it was without the leadership of Chair and Co-Chair, Ed Fullerton and Helaine Campbell. They had a dedicated group of Rotarians and volunteers to help make it so successful.

Club of the Year honors went to the Rotary Club of Sebastopol. Jim Flamson, from the Rotary Club of Calistoga, was named the Rotarian of the Year. And the Rotary International Service Above Self Award recipient was Frank Mayhew, Rotary Club of Sebastopol.

Membership in the District grew slightly by approximately four percent.

## **CLUBS ACHIEVEMENTS**

The Support our Students program initiated by the Santa Rosa Rotary Clubs was an innovative approach to truancy that integrates counseling and prevention early on, so that at-risk kids' involvement with law enforcement can be curtailed or prevented. Law enforcement candidates at Santa Rosa Junior College learn about the Four Way Test, thanks to an innovative award program sponsored by the Santa Rosa East Club. Rotary's polio eradication campaign, in these last, tough years, has made slow and steady progress thanks in great part to donations to the Rotary Foundation. The Lakeport Club raised more than \$3,000 for Polio eradication. And, the Petaluma Valley Rotary used the Foundations' District Simplified Grant program to jump-start a mentoring project for at risk elementary school children in their own community.

A Rotary Club meeting may have been touching, funny, challenging, inspiring or just full of friendly camaraderie, but the Rotary Club of Willits added quite a bit of humorous fun to that town when they brought in the Harlem Ambassadors for exhibition basketball.

At the District Conference we marked twenty years of women in Rotary. And in Healdsburg, Rotarians have funded a math and science project for girls, an effort which will someday help develop vast untapped talent, just waiting for development and recognition.

Everyone in the Eureka area must know about Eureka Rotary's ongoing projects to renovate and improve youth athletic fields. And this year they provided dental care to low-income youth. Mendocino Rotary's Art Auction fits in beautifully with the culture of that town and provides a major source of funds for their scholarships and literacy programs. Several Clubs put on meals



for the elderly, not necessarily as a charitable gesture but as one of friendship and community. And the Fortuna Sunrise Rotary Club donated \$500 to a capital campaign for a local Alzheimer's Center. Then, an anonymous club member pledged an additional \$9,500.

Many of you know about our wonderful Festival of Brotherhood, which has created international projects in central Mexico. At the conference we welcomed the Group Study Exchange Team from District 4150 and got to know them personally.

And what about the Rohnert Park-Cotati Club? They started the year with 44 members and plenty of room in their meeting place. But the club leaders looked around and asked one very fruitful question: Can our community benefit from more Rotary service? And the answer was the brand new Rotary Club of Rancho Cotati, officially chartered by RI on May 14, 2007 with 43 members. And the Rohnert Park-Cotati Club has grown to 47 members!

Michael Murray, a Rotarian in the Napa Sunrise club, says this: "It's never too early to create 'little capitalists' so that club helps do that by supporting Junior Achievement. Many community leaders have noted the challenge of illiteracy among adults in their community, and the Sebastopol Sunrise Club took this into their own hands. They approached a day labor center serving migrant workers and said, "We'll help." And in another very contemporary approach to literacy, The Rotary Club of Arcata has helped their town maintain a Youth Computer Room at the Community Center.

All Rotary clubs talk about the need to increase our visibility. Lakeport has done exactly that with its "Rotary Top Forty" Program, which calls attention to student achievement at many levels. Meanwhile, Clear Lake has been busy starting a new Rotaract Club through their local community college branch, proving that small clubs with big hearts can create a huge impact. Three clubs in Eureka each received grants from Rotary International, of \$1,500 each, for Rotary Public Image projects: Eureka, Southwest Eureka, and Old Town Eureka. The Petaluma Valley Club received a \$2,000 Public Image Grant.

The Committee on the Shelterless in Rohnert Park has benefited enormously from the hands-on involvement of Rotarians. They have creatively and diligently provided direct services to ease the lives of people less fortunate than we are. Lakeport Rotary has organized food baskets, and they've done so not just with their own contributions but also by involving the community in those efforts. The results have included a well-deserved spotlight on the humanitarian nature of local Rotary Clubs. More and more it is not unusual to see clubs such as Mendocino, Windsor, Santa Rosa Sunrise and more giving ten, twelve or more scholarships of \$1,000 to graduating high school seniors. So often a check isn't just a check, but a very much appreciated contribution that can help dreams come true.

Not only have clubs across this district recognized Students of the Month for academic performance. In recent years, many clubs have added "Vocational Students of the Month" and R.O.P. Students of the Month, encouraging career-oriented students who are talented in skills essential to the future prosperity of our state. In addition, Rotarians have not overlooked the alternative and continuation high schools, in scholarships, in Interact Clubs and in recognition for the challenges these students face. District 5130 Rotarians were generous in their contributions to The Rotary Foundation and the accomplishments are too big to be summarized on two pages. I can only say, "thank you" and "oh, aren't you great!"

## APPENDIX 1

### CHARTER DATES OF CLUBS

San Francisco	12 November 1908	Terra Linda	25 July 1964
Napa	1 April 1920	West Santa Rosa	15 April 1965
Santa Rosa	1 December 1921	Mendocino	21 November 1966
San Rafael	1 May 1922	Millbrae	5 February 1966
Petaluma	30 March 1923	Ferndale	29 April 1968
Eureka	9 November 1923	Southwest Eureka	13 March 1969
San Mateo	15 January 1924	Santa Rosa East	10 June 1970
Calistoga	10 March 1924	Half Moon Bay	7 June 1971
Burlingame	2 January 1925	Clear Lake	28 April 1973
Ross Valley (San Anselmo)	27 April 1925	Central Marin	26 June 1973
Ukiah	29 April 1925	South Ukiah	11 December 1973
Lakeport	6 May 1925	Petaluma Valley	16 August 1974
Sebastopol	26 May 1925	North Napa	18 March 1975
Arcata	8 February 1926	Ignacio	12 April 1976
St. Helena	8 March 1926	Mad River (McKinleyville)	29 April 1976
Cloverdale	2 June 1926	Foster City	13 January 1977
Mill Valley	7 June 1926	Rohnert Park-Cotati	28 April 1977
Fortuna	5 January 1927	Tiburon-Belvedere	6 June 1977
Guerneville	6 June 1931	Mission San Rafael	27 January 1982
Garberville	11 January 1938	San Mateo Evening	10 June 1983
Redwood City	1 April 1946	San Francisco West	26 October 1984
Sonoma Valley	24 April 1946	Middletown	19 April 1985
Menlo Park	21 January 1947	Marin Evening	23 May 1985
San Bruno	27 March 1947	Redwood Shores	25 June 1985
Healdsburg	4 February 1948	San Mateo Sunrise	12 June 1986
Sausalito	17 March 1948	Santa Rosa Sunrise	30 June 1986
Willits	6 April 1948	Gualala	4 May 1987
San Carlos	5 January 1949	Larkspur Landing	28 May 1987
Ft. Bragg	25 October 1950	Windsor	22 September 1987
South San Francisco	14 May 1951	Peninsula Sunrise	21 March 1988
Crescent City	24 November 1953	Old Town Eureka	30 June 1988
Novato	26 April 1954	Napa Sunrise	25 July 1988
Daly City	8 June 1954	Arcata Sunrise	17 February 1992
Belmont	19 June 1959	Fortuna Sunrise	23 February 1995
Pacifica	13 September 1962	Del Norte Sunrise	13 April 1995
		Sebastopol Sunrise	1997
		Valley of the Moon	25 April 2000
		Petaluma Sunrise	3 May 2001
		Rancho Cotato	21 May 2007

## DISTRICT CHRONOLOGY

YEAR	GOVERNOR	HOME CLUB	DISTRICT CONFERENCE	CONVENTION
<b>DISTRICT 13</b>				
1915-16	Henry J. Brunnier	San Francisco	Fresno	Cincinnati
1916-17	Homer W. Sumption	San Diego	Los Angeles	Atlanta
1917-18	Dr. Dewey R. Powell	Stockton	Sacramento	Kansas City
<b>DISTRICT 23</b>				
1918-19	Clinton E. Miller	Los Angeles	San Diego	Salt Lake City
1919-20	Alex Sheriffs	San Jose	Oakland	Atlantic City
1920-21	Leslie S. Everts	San Diego	Long Beach	Edinburgh, Scotland
1921-22	Charles B. Bills	Sacramento	S.F. (renamed R.I.)	Los Angeles
<b>DISTRICT 2</b>				
1922-23	John R. Williams	Long Beach	Pasadena	St. Louis
1923-24	Paul Rieger	San Francisco	San Jose	Toronto, Canada
1924-25	Harry S. Mason	Los Angeles	Fresno	Cleveland
1925-26	Thomas B. Bridges	Oakland	San Diego	Denver
1926-27	Fred A. McClung	Huntington Park	Stockton	Ostend, France
1927-28	Almon E. Roth	Palo Alto	Sacramento	Minneapolis
1928-29	Herbert E. Harris	Whittier	Los Angeles	Dallas
1929-30	Harvey B. Lyon	Oakland	Oakland	Chicago
1930-31	Arthur S. Crites	Bakersfield	Catalina Island	Vienna, Austria
1931-32	David J. Reese	Ventura	San Francisco	Seattle
1932-33	Charles D. Hayward	Berkeley	Pasadena	Boston
1933-34	Edward B. DeGrott	Los Angeles	Fresno	Detroit
1934-35	Herbert K. Walton	San Rafael	Santa Monica	Mexico City, Mexico
1935-36	George W. MacLellan	Santa Barbara	Berkeley	Atlantic City
1936-37	Marshall DeMott	Corning	Hollywood	Nice, France
<b>DISTRICT 104</b>				
1937-38	Charles L. Wheeler	San Francisco	San Francisco	San Francisco
1938-39	Floyd A. Parton	San Jose	San Jose	Cleveland
1939-40	Russell F. O'Hara	Vallejo	Santa Cruz	Havana, Cuba
1940-41	Harry A. Mitchell	San Francisco	San Francisco	Denver
1941-42	Roy N. Dreiman	Santa Cruz	Oakland	Toronto, Canada
<b>DISTRICT 104-105 JOINT</b>				
1942-43	Frank Brennan	Eureka	Eureka	St. Louis
1943-44	J. Percy Robinson	San Mateo		
	Mervin Hitchcock	San Mateo	San Francisco	Chicago
1944-45	Prentiss A. Rowe	San Francisco	Cancelled a/c war	Chicago
1945-46	Joseph L. Gabriel	Hollister	Sonoma Mission Inn	Atlantic City
1946-47	Clarence C. Price	Vallejo	San Francisco	San Francisco
1947-48	Frank E. Allen	Burlingame	Santa Cruz	Rio de Janeiro, Brazil
1948-49	Harold D. Bostock	Santa Rosa	Hoberg's	New York
<b>DISTRICT 155</b>				
1949-50	Herbert S. Shuey	San Francisco	San Francisco	Detroit
1950-51	William E. Williams	San Jose	San Jose	Atlantic City
1951-52	Bernard J. Bush	Garberville	Hoberg's	Mexico City, Mexico
1952-53	Wm. Otis Callaway	Burlingame	Hoberg's	Paris, France
1953-54	Wallace S. Meyers	San Anselmo	Hoberg's	Seattle
1954-55	G. P. Bacon	Santa Cruz	Santa Cruz	Chicago
1955-56	E. W. Stephens	San Francisco	San Francisco	Philadelphia
1956-57	George B. Chaffey	Vallejo	Hoberg's	Lucerne, Switzerland



### DISTRICT 513

1957-58	Monroe E. Brown	Burlingame	San Jose	Dallas
1958-59	Lloyd Hayes	Sebastopol	Santa Rosa	New York
1959-60	Dr. Walter J. Hamilton	San Carlos	San Mateo	Miami Beach
1960-61	Francis Whitmer	San Francisco		
	Dr. Walter J. Hamilton	San Carlos	San Francisco	Tokyo, Japan
1961-62	Norman LeLaittre	Cloverdale	Santa Rosa	Los Angeles
1962-63	Percival M. Bliss	West San Jose	Palo Alto	St. Louis
1963-64	Harold E. Tucker	Garberville	Eureka	Toronto, Canada
1964-65	Stanley McCaffrey	San Francisco	San Francisco	Atlantic City
1965-66	George Starbird	San Jose	San Jose	Denver
1966-67	Stanley L. Lance	Santa Rosa	Santa Rosa	Nice, France
1967-68	Jack B. Power	Palo Alto	Palo Alto	Mexico City, Mexico
1968-69	Robert E. Barwick	Napa	Napa	Honolulu
1969-70	Harold Graves	Mill Valley	San Francisco	Atlanta
1970-71	Ray Winther	So. San Francisco	Burlingame	Sydney, Australia
1971-72	Charlie Strobe	Eureka	Eureka	Houston
1972-73	Alfred D. Quilici	San Rafael	San Rafael	Lausanne, Switzerland
1973-74	John K. Withers	West Santa Rosa	Tahoe	Minneapolis-St .Paul
1974-75	Robert C. Glidden	So. San Francisco	Monterey	Montreal, Canada
1975-76	William A. Jamieson	Fortuna	Eureka	New Orleans
1976-77	George P. Newlon	San Mateo	Clear Lake	San Francisco
1977-78	Arthur W. Agnew	Petaluma	Santa Rosa	Tokyo, Japan
1978-79	Robert J. Paroli	Menlo Park	Clear Lake	Rome, Italy
1979-80	Harry C. Empey	Santa Rosa	Clear Lake	Chicago
1980-81	Reuben W. Kaehler	Novato	Sacramento	Sao Paulo, Brazil
1981-82	Robert R. Rockwell	San Francisco	Napa	Dallas
1982-83	Richard L. Keith	West Santa Rosa	Reno	Toronto, Canada
1983-84	Clifton C. McGarr	San Rafael	Concord	Birmingham, England
1984-85	Larry D. Myers	South Ukiah	Ukiah	Kansas City
1985-86	Norman Lawrence	Ignacio	Santa Rosa	Las Vegas
1986-87	Sidney L. Berlin	Redwood City	San Francisco	Munich, Germany
1987-88	Aldo I. Simonetti	Burlingame	Clear Lake	Philadelphia
1988-89	Robert V. Kane	Tiburon-Belvedere	Sacramento	Seoul, Korea

### DISTRICT 513

1989-90	John M. Vallerga	Santa Rosa East	Rohnert Park	Portland, Oregon
1990-91	John T. Blount	Sebastopol	Sacramento	Mexico City, Mexico

### DISTRICT 5130

1991-92	David M. Dillon	Eureka	Eureka	Orlando, Florida
1992-93	Delbert A. Raby	Santa Rosa Sunrise	Rohnert Park	Melbourne, Australia
1993-94	Duane Blackwill	Petaluma	Rohnert Park	Taipei, Republic of China
1994-95	John G. Strong	Petaluma Valley	Konocti-Clear Lake	Nice, France
1995-96	Cameron L. Reeves	Lakeport	Konocti-Clear Lake	Calgary, Canada
1996-97	Larry Kavanaugh	Southwest Eureka	Konocti-Clear Lake	Glasgow, Scotland
1997-98	Lawrence P. Bello	Santa Rosa	Rohnert Park	Indianapolis
1998-99	Louis G. Delsol	Ukiah	Ukiah	Singapore
1999-00	Michael P. Merrill	Santa Rosa West	Ukiah	Buenos Aires, Argentina
2000-01	Harry N. Johnson	Arcata Sunrise	Konocti-Clear Lake	San Antonio
2001-02	Franz A. Wartenweiler	Napa Sunrise	Yountville	Barcelona, Spain
2002-03	Terri L. Clark	Southwest Eureka	Fortuna	Brisbane, Australia
2003-04	Norm M. Owen	Santa Rosa	Santa Rosa	Osaka, Japan
2004-05	Bruce S. Campbell	Sebastopol Sunrise	Rohnert Park	Chicago
2005-06	Charlie Kelly	South Ukiah	Konocti-Clear Lake	Copenhagen, Denmark
2006-07	Erna M. Stevenson	North Napa	Rohnert Park	Salt Lake City

**Rotary District 5130 .. Family Tree (April 2007)**

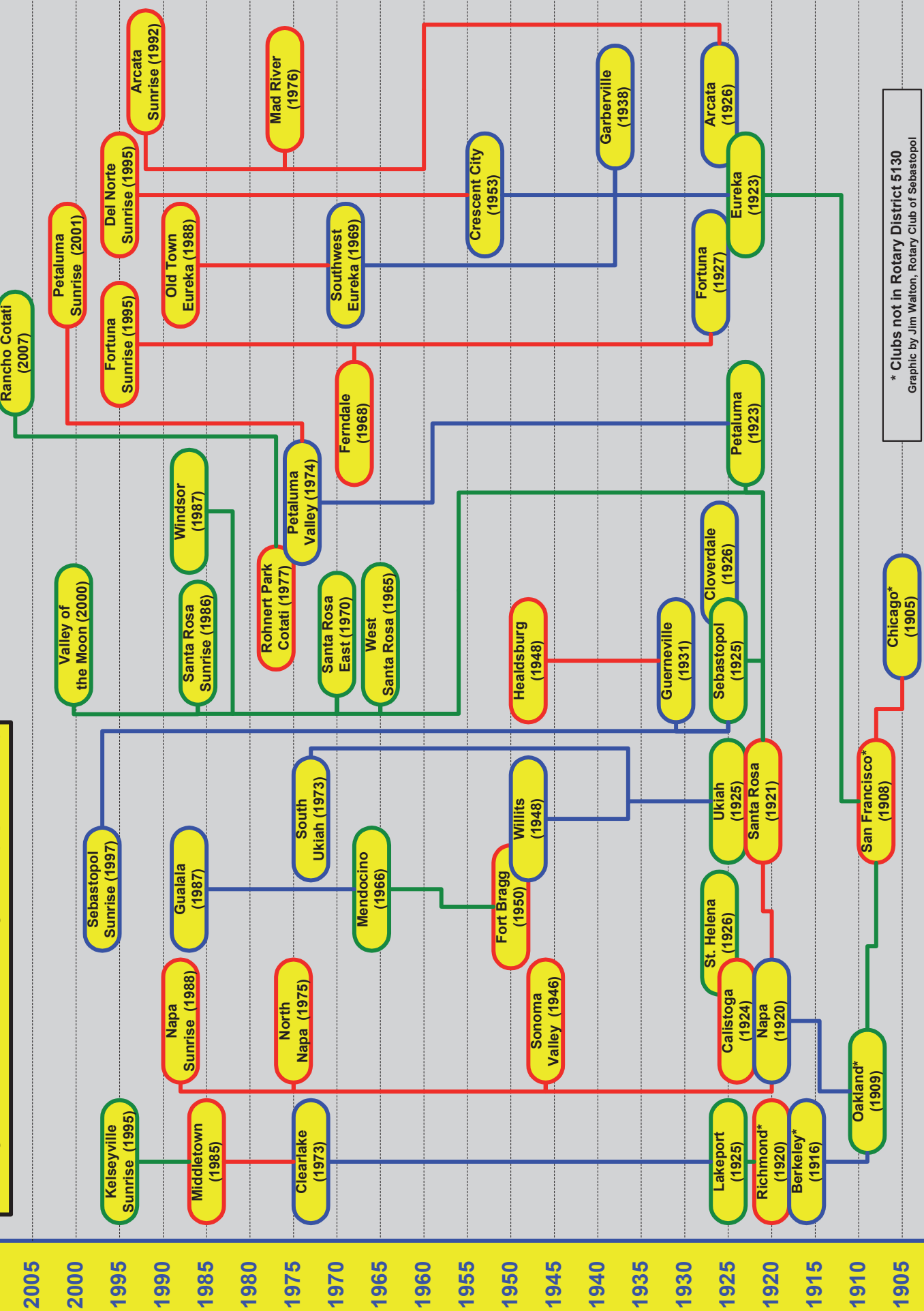

\* Clubs not in Rotary District 5130  
Graphic by Jim Walton, Rotary Club of Sebastopol

